



User Manual

Outdoor HD IP Camera



Model: FI9804W



Model: FI9805W



Model: FI9805E



Model: FI9803EP



Model: FI9803P



Model: FI9903P



Model: FI9900P/FI9800P



Model: FI9900EP/ FI9901EP

Table of Contents

Table of Contents.....	1
Security Warning.....	4
1 Overviews.....	4
1.1 Key Features.....	4
1.2 PoE (Power over Ethernet- FI9805E/FI9803EP/FI9900EP/FI9901EP).....	5
1.3 Read Before Use.....	5
1.4 Packing Contents.....	6
1.5 Physical Description.....	6
1.5.1 Front Panel.....	6
1.5.2 Interface.....	8
1.5.3 Bottom View.....	9
1.6 SD Card Management.....	10
1.7 Wall installation.....	11
1.8 The different features between the models involved.....	12
2 Access the IP Camera.....	12
2.1 Hardware Connection & Software Installation.....	12
2.2 Access the Camera in LAN.....	13
2.2.1 Wired connection.....	13
2.2.2 Wireless connection.....	14
2.3 Access the Camera in WAN.....	14
2.3.1 Static IP Addresses.....	14
2.3.2 Remote Access.....	15
2.4 Using the VLC player.....	18
2.5 IP camera connection to the server.....	20
3 Surveillance Software GUI.....	21
3.1 Login Window.....	21
3.2 Surveillance Window.....	24
4 Advanced Camera Settings.....	31
4.1 Setup Wizard.....	31
4.2 Device Status.....	31
4.2.1 Device Information.....	31
4.2.2 Device Status.....	32
4.2.3 Session status.....	32
4.2.4 Log.....	32
4.3 Basic Settings.....	33
4.3.1 Camera Name.....	33
4.3.2 Camera Time.....	33
4.3.3 User Accounts.....	34
4.3.4 Multi-Camera.....	36
4.4 Network.....	40
4.4.1 IP Configuration.....	40
4.4.2 Wireless Settings(FI9803P/FI9804W/FI9805W/FI9900P/FI9800P).....	42

4.4.3 PPPoE.....	44
4.4.4 DDNS.....	44
4.4.5 UPnP.....	48
4.4.6 Port.....	48
4.4.7 Mail Settings.....	50
4.4.8 FTP Settings.....	52
4.4.9 P2P (Except FI9804W/ FI9805W/ FI9805E).....	53
4.5 Video.....	53
4.5.1 Video Settings.....	53
4.5.2 On Screen Display.....	55
4.5.3 Privacy Zone.....	55
4.5.4 Snapshot Settings.....	56
4.5.5 IR LED Schedule.....	58
4.6 Detector.....	58
4.6.1 Motion Detection.....	58
4.6.2 Sound Detection.....	61
4.6.3 IO Alarm(only FI9805E).....	62
4.7 Record.....	64
4.7.1 Storage Location.....	64
4.7.2 Alarm Record.....	65
4.7.3 Local Alarm Location.....	65
4.7.4 Schedule Recording.....	65
4.7.5 SD Card Management(FI9803EP/FI9900P/FI9900EP/FI9901EP).....	67
4.8 PTZ(only FI9805E).....	68
4.8.1 Pan/Tilt Speed.....	68
4.8.2 RS485 Configuration.....	68
4.9 Firewall.....	68
4.10 System.....	69
4.10.1 Back-up& Restore.....	69
4.10.2 System Upgrade.....	70
4.10.3 Patch Installation.....	72
4.10.4 Factory Reset.....	72
4.10.5 Reboot.....	72
5 Playback(FI9803EP/FI9900P/FI9900EP).....	73
6 Appendix.....	74
6.1 Frequently Asked Questions.....	74
6.1.1 Install the ActiveX of Firefox browser, Google Chrome and IE Chrome.....	74
6.1.2 Uninstall the ActiveX of Firefox browser, Google Chrome and IE Chrome.....	77
6.1.3 I have forgotten the administrator password.....	79
6.1.4 Subnet doesn't match.....	79
6.1.5 Camera can not record.....	79
6.1.6 No Pictures Problems.....	79
6.1.7 Can't access IP camera in internet.....	80
6.1.8 UPnP always failed.....	81
6.1.9 Camera can not connect wireless.....	81
6.2 Default Parameters.....	81

6.3 Specification.....	81
6.4 CE & FCC.....	93
6.5 WARRANTY.....	94
6.6 Statement.....	97
7 Obtaining Technical Support.....	98

Security Warning

1. Foscam cameras and NVRs require good security practices to safeguard your privacy. You should regularly change your camera or NVR password which is 8-10 numbers, letters, symbols combination.
2. You should update your camera or NVR regularly. Make sure your camera or NVR has the latest firmware installed for your specific model and better experience.

1 Overviews

FOSCAM Outdoor HD IP Camera is an integrated wireless IP Camera with a color CMOS sensor enabling viewing in High Definition resolution. It combines a high quality digital video camera, with a powerful web server, to bring clear video to your desktop from anywhere on your local network or over the Internet.

The IP Camera supports the industry-standard H.264 compression technology, drastically reducing file sizes and conserving valuable network bandwidth.

The IP Camera is based on the TCP/IP standard. There is a WEB server inside which could support Internet Explorer. Therefore the management and maintenance of your device is simplified by using the network to achieve the remote configuration and start-up.

The camera is designed for outdoor surveillance applications such as courtyards, supermarket, and school. Controlling the IPCAM and managing images are simplified by using the provided web interface across the network utilizing wireless connectivity.

FOSCAM provides Phone APPs for Android and iPhone users, please search and install App on App Store and Google Play for iOS and Android devices, then you can view your camera anywhere, anytime on your smart mobile devices.

1.1 Key Features

- ◆ Standard H.264 video compression algorithm to satisfy the transmission of high definition video in narrow bandwidth network
- ◆ 1.0 Mega-Pixel(FI9803P, FI9800P, FI9803EP,FI9804W) / 1.3 Mega-Pixel (FI9805W, FI9805E)/ 2.0 Mega-Pixel (FI9903P, FI9900P, FI9900EP)/ 4.0 Mega-Pixel (FI9901EP)
- ◆ Supports IE/Firefox/Google/Safari browser or any other standard browsers
- ◆ Supports WEP,WPA and WPA2 Encryption

- ◆ Wi-Fi compliant with wireless standards IEEE 802.11b/g/n (FI9804W, FI9805W, FI9803P, FI9800P, FI9900P)
- ◆ PoE compliant with PoE standards IEEE 802.3af (FI9805E, FI9803EP, FI9900EP, FI9901EP)
- ◆ IR night vision, Range:20m (FI9803P, FI9800P, FI9900P, FI9900EP, FI9803EP, FI9804W, FI9901EP)/ 30m (FI9805W, FI9805E,FI9903P)
- ◆ Supports image snapshot
- ◆ Supports dual-stream
- ◆ Supports IR-Cut and the filter change automatically
- ◆ Embedded FOSCAM DDNS(dynamic domain name service) Service
- ◆ Supports remote viewing & record from anywhere anytime
- ◆ Multi-level users management with password protection
- ◆ Motion detection alert via email or upload image to FTP
- ◆ Supporting Third Party Domain name
- ◆ Providing Phone APPs for Android and iPhone users
- ◆ Supports multiple network protocols: HTTP /HTTPS/ RTSP/ TCP /IP /UDP /FTP /DHCP /DDNS /UPNP/ONVIF
- ◆ Providing Central Management Software to manage or monitor multi-cameras
- ◆ Supports magic zoom(FI9900P, FI9900EP, FI9901EP)
- ◆ Supports High Dynamic Range(FI9900P, FI9900EP, FI9901EP)

1.2 PoE (Power over Ethernet-

FI9805E/FI9803EP/FI9900EP/FI9901EP)

The Network Camera is PoE-compliant, allowing transmission of power and data via a single Ethernet cable. Such as the following picture: connect the Network Camera to a PoE-enabled router/ switch via Ethernet cable.

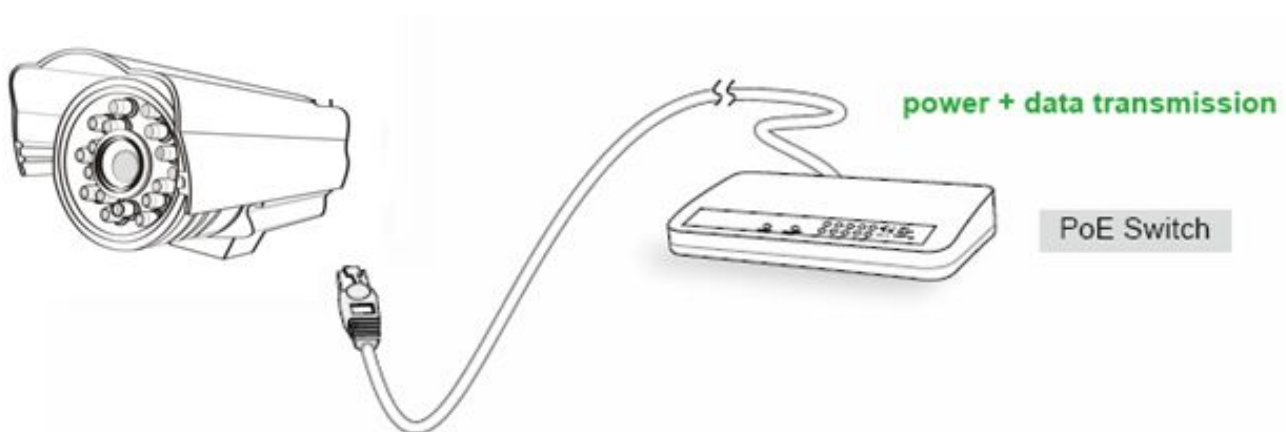

1.3 Read Before Use

Please first verify that all contents received are complete according to the Package Contents listed below. Before the Network Camera is installed, please carefully read and follow the instructions in the Quick Installation Guide to avoid damage due to faulty assembly and installation. This also ensures the product is used properly as intended.

1.4 Packing Contents

● IPCAM×1	● CD×1
● Wi-Fi Antenna×1 (except for FI9805E, FI9803EP, FI9903P, FI9900EP, FI9901EP)	● Quick Installation Guide ×1
● DC Power Supply×1	● Warranty Card×1
● Mounting bracket×1 (except for FI9900P, FI9900EP, FI9800P, FI9901EP)	● Network Cable×1

1.5 Physical Description

1.5.1 Front Panel

Front Panel for FI9804W/FI9805W/FI9805E



Figure 1.1

- 1 WIFI Antenna:** Wireless Antenna (FI9804W, FI9805W)
- 2 Infrared LED:** 12 IR LEDs (FI9804W), 36 IR LEDs (FI9805W, FI9805E)
- 3 LENS:** CMOS sensor with fixed focus lens
- 4 Induction IC**

Front Panel for FI9803EP/FI9803P



Figure 1.2

- 1 **WiFi Antenna:** Wireless Antenna (FI9803P)
- 2 **Infrared Lamp Array**
- 3 **LENS:** CMOS sensor with fixed focus lens
- 4 **Induction IC**

Front Panel for FI9903P

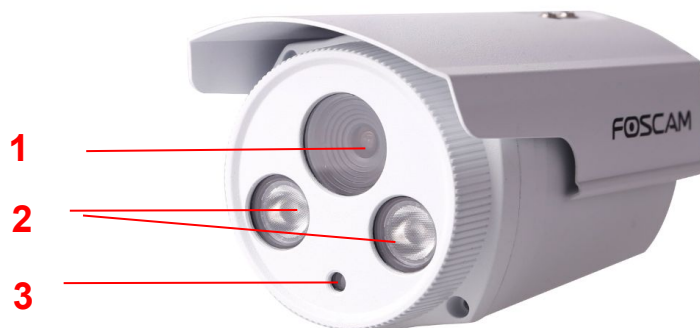

Figure 1.3

- 1 **LENS:** CMOS sensor with fixed focus lens
- 2 **Infrared Lamp Array**
- 3 **Induction IC**

Front Panel for FI9900P/FI9900EP/FI9800P/ FI9901EP



- 1 WIFI Antenna:** Wireless Antenna(FI9900P/ FI9800P)
- 2 Infrared LED:** 30 IR LEDs
- 3 LENS:** CMOS sensor
- 4 Induction IC**

1.5.2 Interface

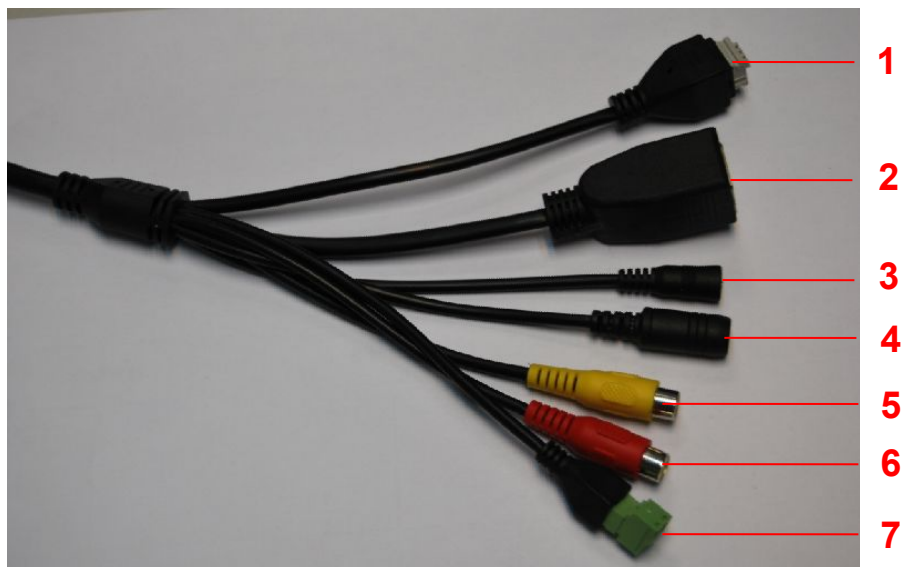

Figure 1.4

1 I/O alarm terminal block (Only FI9805E)

This network camera provides a I/O alarm terminal block which is used to connect to external input / output device.

The pin(there are four number in the terminal block from no. 1 to no. 4) definitions are as follows:

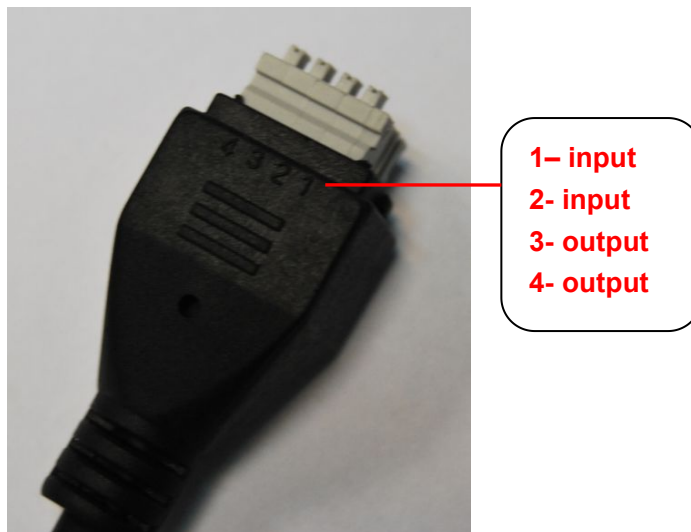

Figure 1.5

This camera supports I/O alarm, you can go to **Settings-Alarm - I/O** page to configure it.

2 LAN

10/100M adaptive Ethernet interface. Through this interface, IPCAM can be connected with various network devices, such as hub, router, etc.

3 Reset button

Press and hold on the reset button for 5 seconds. Releasing the reset button, the password will back to the factory default administrator password. The default administrator user is admin with no password.

4 Power Interface

Connect the external power adapter, request for 12V/2A or 12V/1A power.

5 Audio input interface (Except FI9803EP/ FI9903P)

The jack is used to plug external input device such as sound pick up device directly. Here microphone cannot directly insert to the interface, it must connect to adapter first.

6 Audio output interface(Except FI9803EP/ FI9903P)

The jack is used to plug external output device such as loud speaker directly. Here microphone cannot directly insert to the interface, it must connect to adapter first.

7 RS485 Cradle head interface (Except FI9803EP/ FI9903P)

This camera supports the standard 485 cradle head protocol(Pelco-D and Pelco-P). Please configure the RS485 protocol corresponding information first (go to **Settings- PTZ - RS485 Configuration** page and do settings), or else the cradle head may cannot work.

1.5.3 Bottom View

There are up to two labels located at the bottom of the camera, this is an important feature of original Foscam

cameras. If your camera does not have labels, it may be a clone. Cloned Foscam cameras can not use original firmware and are not eligible for warranty or technical services.

1.6 SD Card Management

The record files of the IPC can be stored in the SD Card.

You need open the IP Camera, then plug the SD card into SD card slot inside the IP Camera.

When you plug in the SD card during the camera work process, please reboot the camera again, or else the SD Card may be cannot work well.

Insert Micro SD Card in the location shown below.

FI9803EP

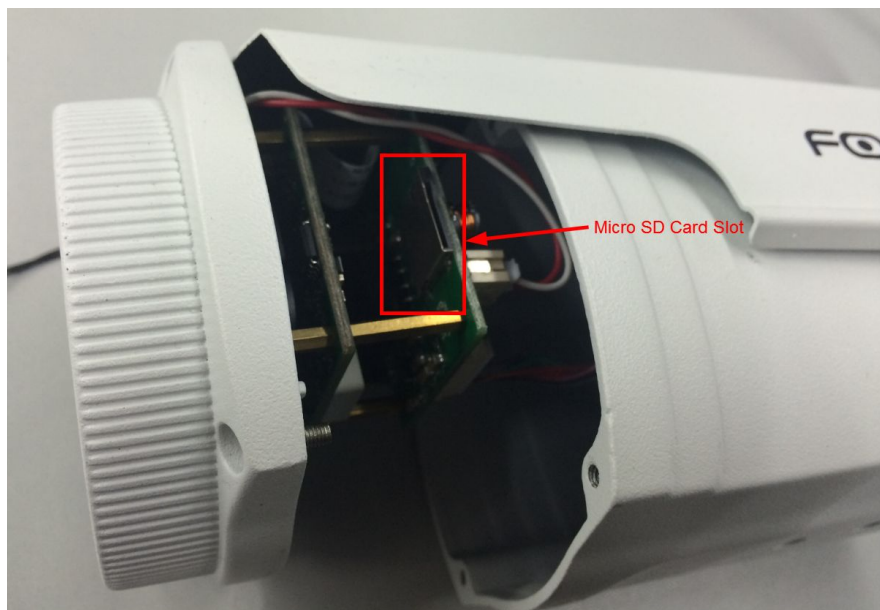

FI9901EP/FI9900P/FI9900EP

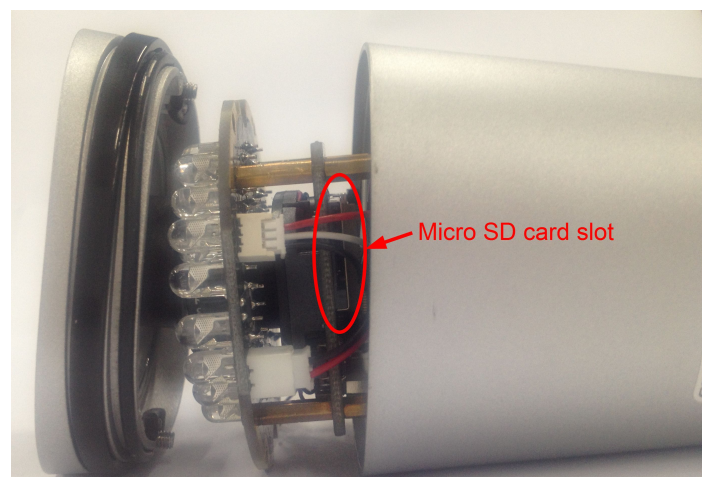

Note:

When you re-install the camera, please ensure the tightness with the camera.

1.7 Wall installation

FI9803EP/ FI9803P/ FI9903P

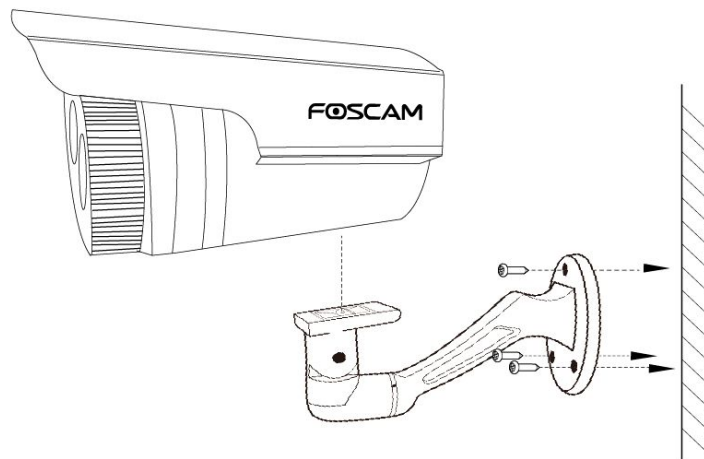

Step 1: Screw the mount on the wall with the 3 screws provided.

Step 2: Install the camera on the mounting bracket with 1 screw to complete installation.

FI9800P/ FI9900P/ FI9900E/ FI9901EP

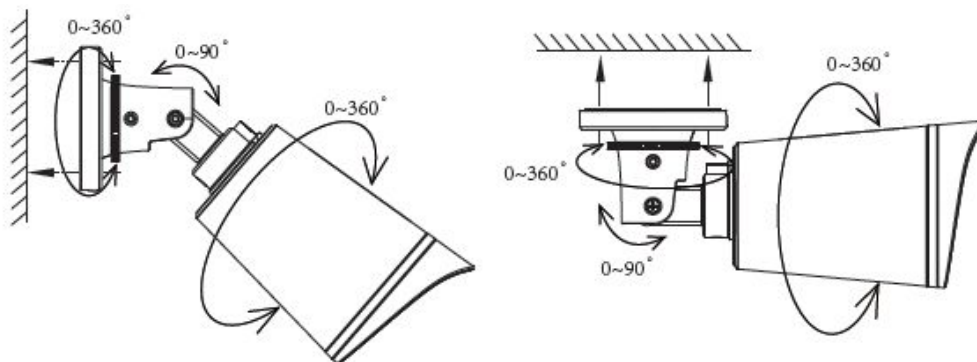

Fixate the camera on your preferred location and use screws to mount it. We have provided screws in the Packaging.

NOTE:

Ensure that the rain or water will not reach the connector ports at the end of the pig tail wiring. These connectors are not weather-resistant.

1.8 The different features between the models involved

Differences						
Model	Wireless	PoE (Power over Ethernet)	Alarm in / out	Audio input /output	RS 485	P2P
FI9804W	√	×	×	√	×	×
FI9805W	√	×	×	√	×	×
FI9805E	×	√	√	√	√	×
FI9803EP	×	√	×	×	×	√
FI9803P	√	×	×	√	×	√
FI9903P	×	×	×	×	×	√
FI9900P	√	×	×	√	×	√
FI9900EP	×	√	×	√	×	√
FI9800P	√	×	×	√	×	√
FI9901EP	×	√	×	√	×	√

2 Access the IP Camera

2.1 Hardware Connection & Software Installation

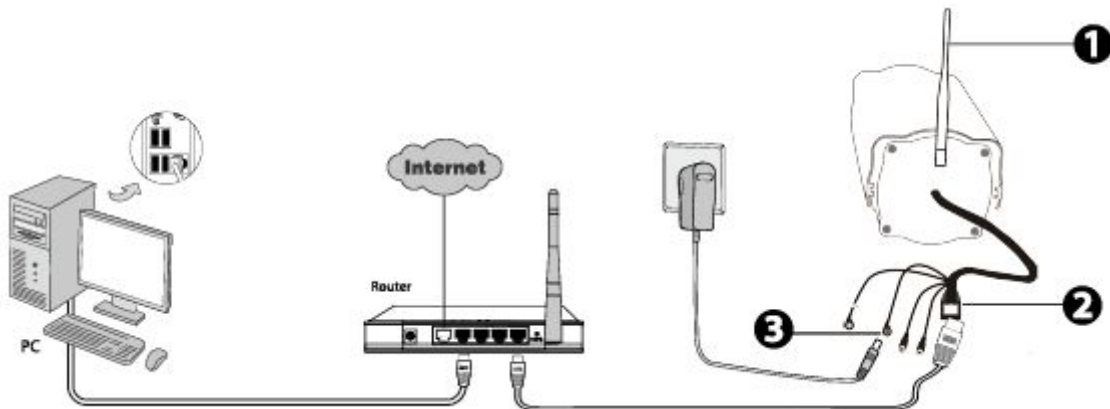
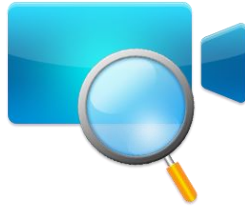

Figure 2.1

1. Mount the antenna and make it stand vertically(Only for the device with external antenna).
2. Connect the camera to the LAN network (Router or Switch) via network cable.
3. Connect the power adapter to the camera.
4. Insert the CD into the CD drive of your computer.
5. Go to the folder "Equipment Search Tool" and find the folder "For Windows OS" or "For Mac OS". Copy and paste the search tool file to your computer, or drag it onto your Desktop.

**Notes:**

- If your computer (Windows OS) supports autorun function, you can find the corresponding file in the opened control panel.
- If your computer doesn't have CD drive, you can download the Equipment Search Tool from our website for free.

2.2 Access the Camera in LAN

2.2.1 Wired connection

The camera supports HTTP and HTTPS protocols, you can access the camera in two ways.

(1) Http:// LAN IP + Http Port No.

The default HTTP port NO. is 88. Double click the Search Tool icon to run, and it should find the camera's IP address automatically after you plug in the network cable.

Camera Name	IP Address	Device ID	Type
Anonymous	Http://192.168.1.105:88	00626E55AB1E	IPC

Figure 2.2

Double click the IP address of the camera; the camera login page should be open in your default browser.

(2) Https:// LAN IP + Https Port no.

The default HTTPS port NO. is 443. You can use the URL to access the camera: https:// LAN IP + HTTPS port NO.

Go to **Settings - Network - Port** panel, you can see and change the HTTP and HTTPS port NO.

Save Refresh	
HTTP Port	88
HTTPS Port	443
ONVIF Port	65533

Figure 2.3

NOTE:

When logging in for the first time, you will need to download and install the add-on.

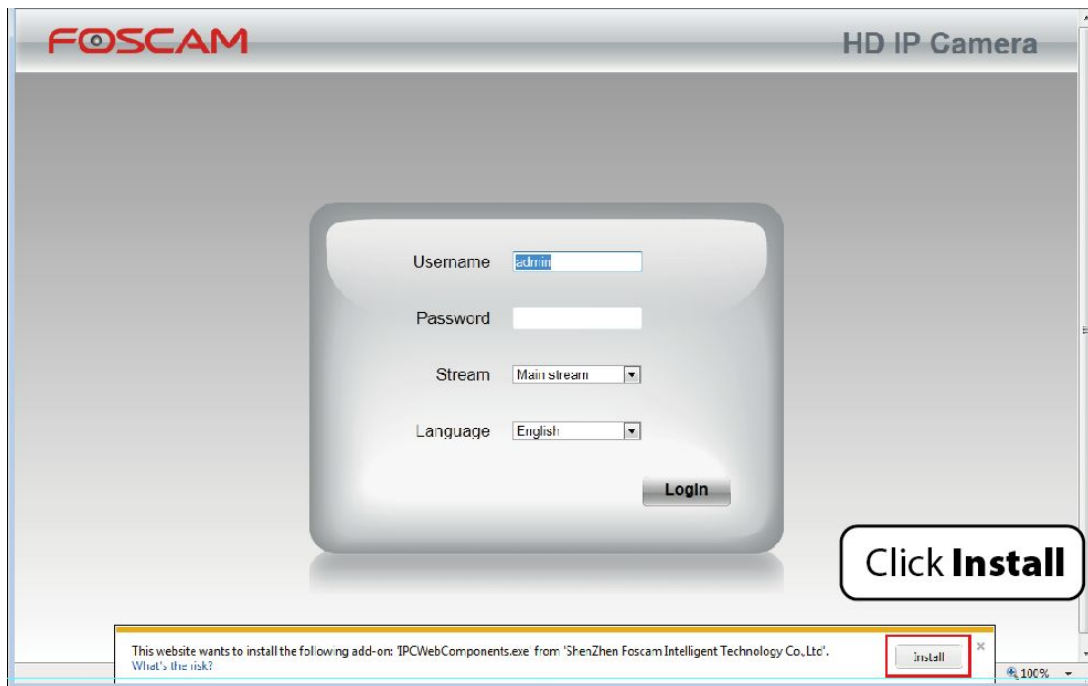

Figure 2.4

2.2.2 Wireless connection

Only some models support EZLink wireless connection , please refer to the Quick Installation Guide.

2.3 Access the Camera in WAN

2.3.1 Static IP Addresses

Users who have static IP addresses do not need to set DDNS service settings for remote access. When you have finished connecting the camera using the LAN IP address and port forwarding, you can access the camera directly from the Internet using the WAN IP address and port number.

How to Obtain the WAN IP address from a public website ?

To obtain your WAN IP address, enter the following URL in your browser: <http://www.whatismyip.com>. The webpage at this address will show you the current WAN IP.



Figure 2.5

Access your IP Camera from the Internet

You can access the IP Camera from the Internet (remote access). Enter the WAN IP address and port number in your standard browser. For example, you would enter `http:// 183.37.28.254:88`

2.3.2 Remote Access

If you want to access your camera by web browser outside of your LAN, you need to configure following configurations.

1. Choose "Settings" on the top of the camera web page, then go to the "Network > IP Configuration" section on the left side of the screen, then uncheck the Obtain IP DHCP.

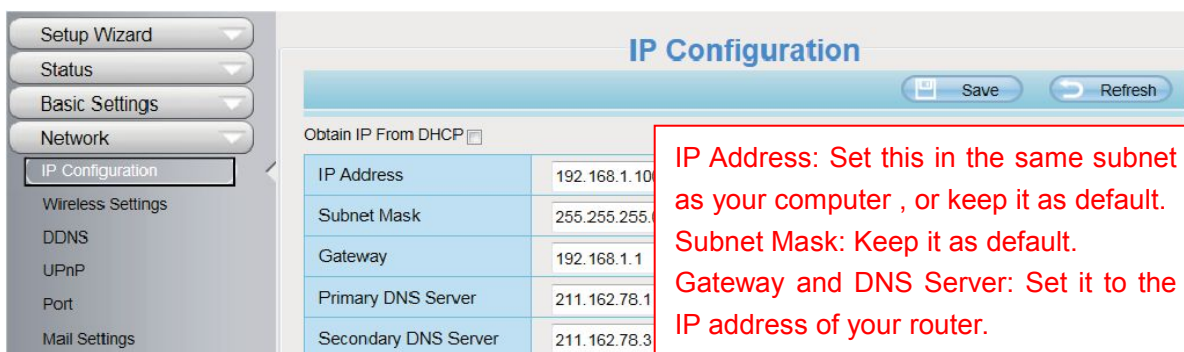

Figure 2.6

2. Enable UPnP and DDNS in the camera's settings page. We recommend you to use the DDNS by factory default.

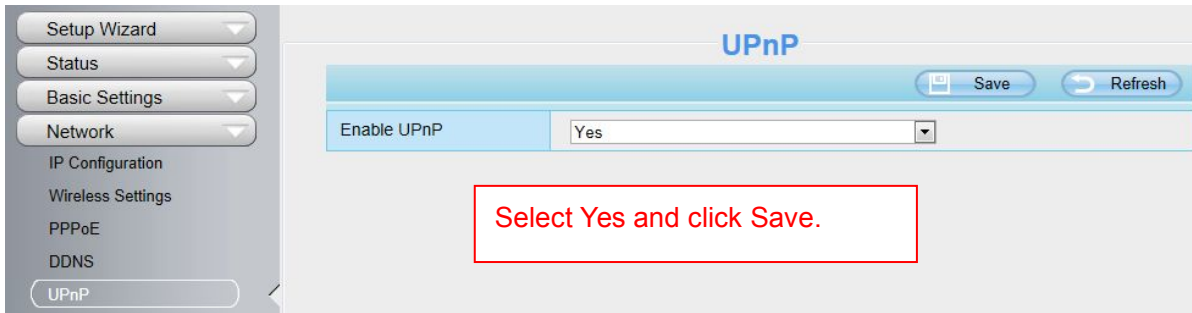

Figure 2.7

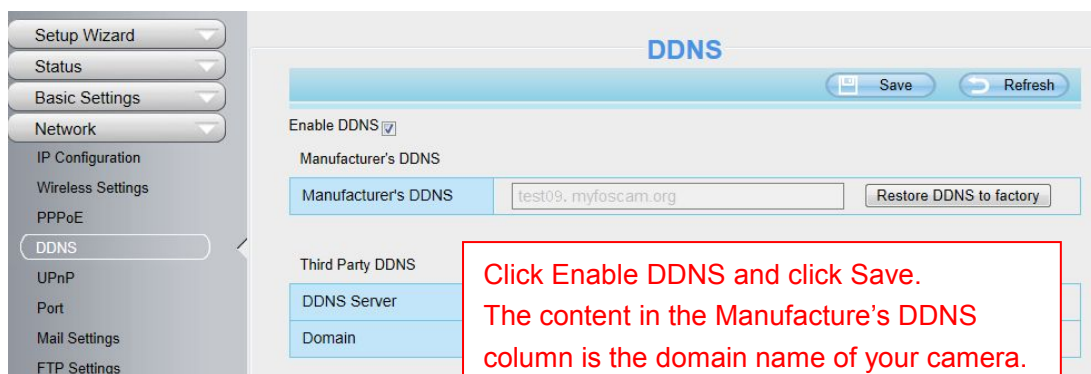

Figure 2.8

3. You can see the port of your camera here. If you want to set Remote Access for several cameras on the same network, you will need to change the HTTPS port for each camera.

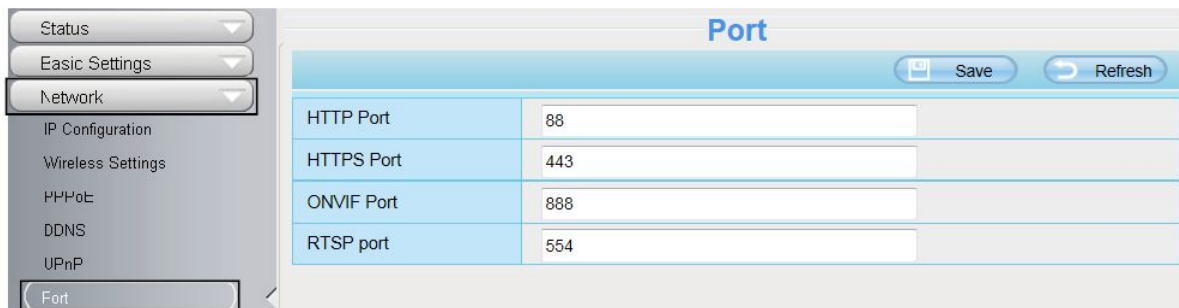

Figure 2.9

4. If the UPnP of the router has been enable, you do not need to perform following steps. Otherwise, you need to select one of the following methods to configure port forwarding on your router. For these steps, we will be using the TP-LINK brand wireless router as an example.

- **If there is a UPnP function in your router:**

Choose "Forwarding > UPnP", make sure that the Current UPnP Status is Enabled.

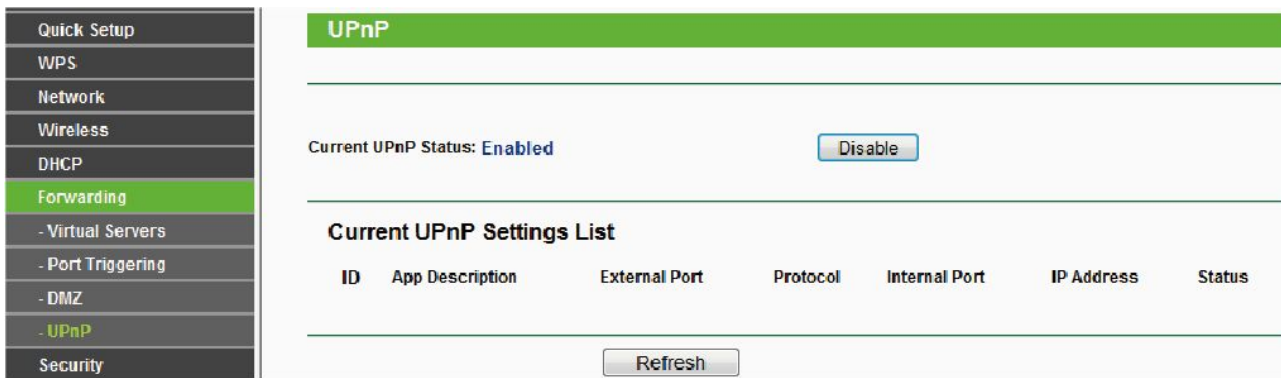

Figure 2.10

- **If there is no UPnP function in your router:**

You need to manually add port(HTTPS port) forwarding, refer to the following steps. You need go to the “Forwarding > Virtual Servers” panel for setup.

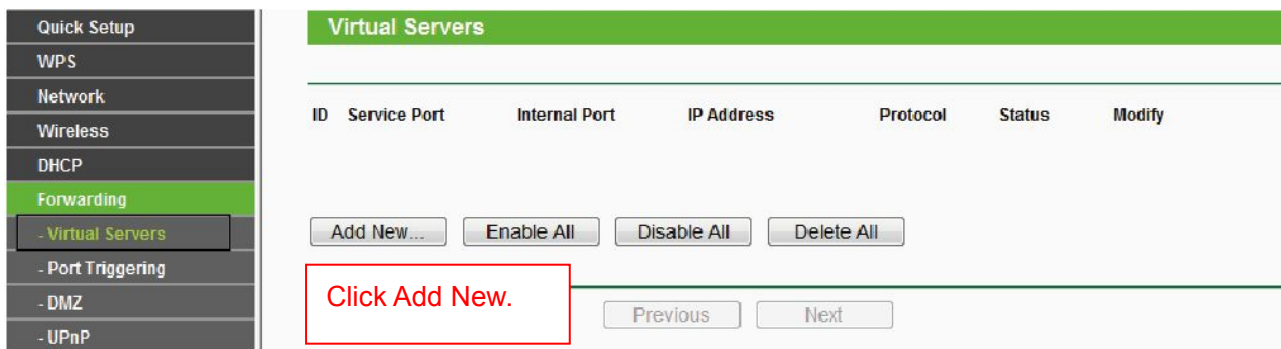

Figure 2.11

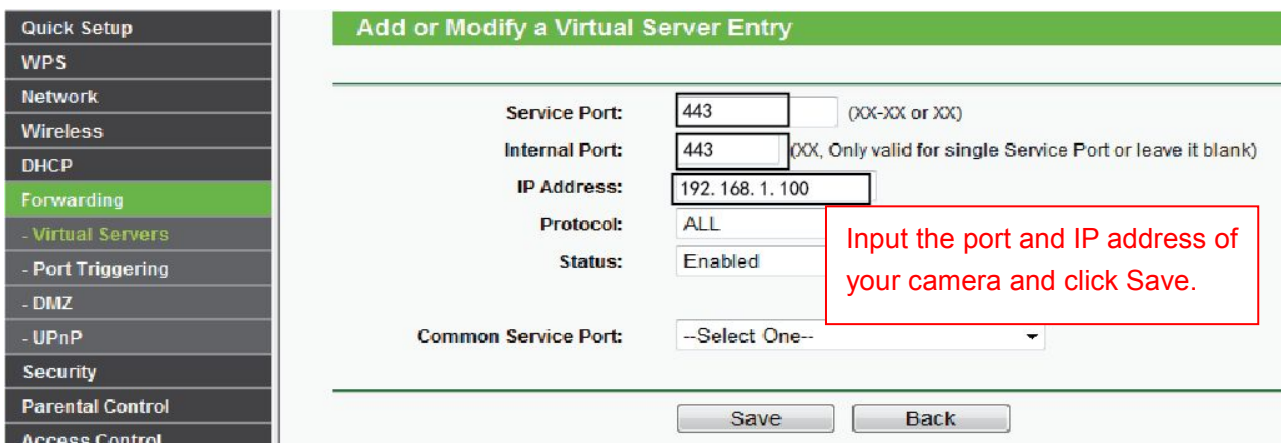

Figure 2.12



Figure 2.13

5. Now you can access your IP camera by <https://domain name: HTTPS port via the Internet>.

2.4 Using the VLC player

This camera supports RTSP streaming, here you can view the camera using VLC player.

RTSP URL [rtsp:// \[user name\]:\[password\]@IP:port number/videosream](rtsp://[user name]:[password]@IP:port number/videosream)

The part in the square brackets may be omitted.

user name & password:

The user name and password to access the camera. This part can be omitted.

IP: WAN or LAN IP address.

port number: If there is the RSTP port number on the Port page, you must only use RTSP port number. otherwise, you must only use http port number.

Videostream: Here support three modes: videoMain, videoSub and audio. When the network speed is bad, here you had better select videoSub. If you select audio, you can only hear the sound but cannot see the video.

For example:

IP: 192.168.1.11

Port number: 88

User name: admin

Password: 123

Here I can enter one of the following URLs in the VLC.

1. <rtsp://admin:123@192.168.1.11:88/videoMain>
2. [rtsp:// @192.168.1.11:88/videoMain](rtsp://@192.168.1.11:88/videoMain)
3. <rtsp://:123@192.168.1.11:88/videoMain>
4. <rtsp://admin@192.168.1.11:88/videoMain>

Open the VLC, and go to Media(Open Network Stream option, then enter the URL into VLC.

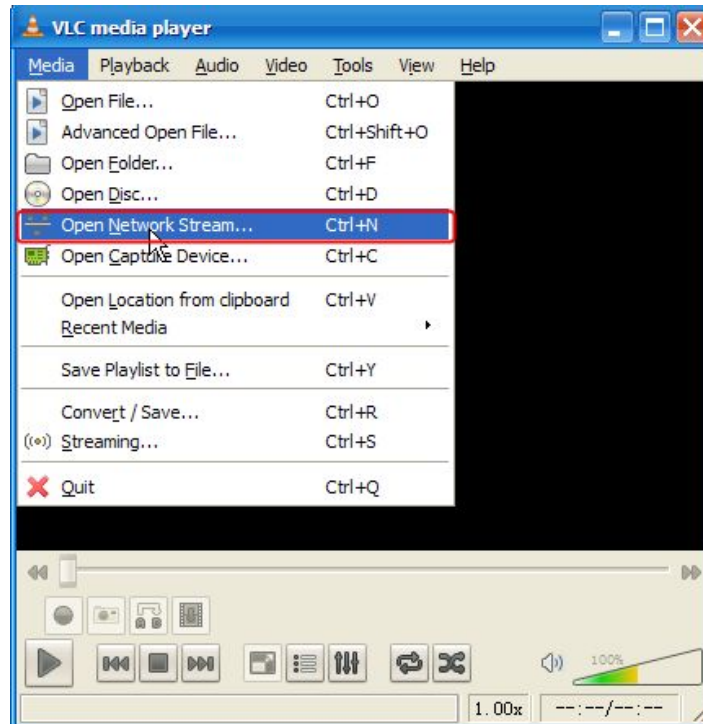

Figure 2.14

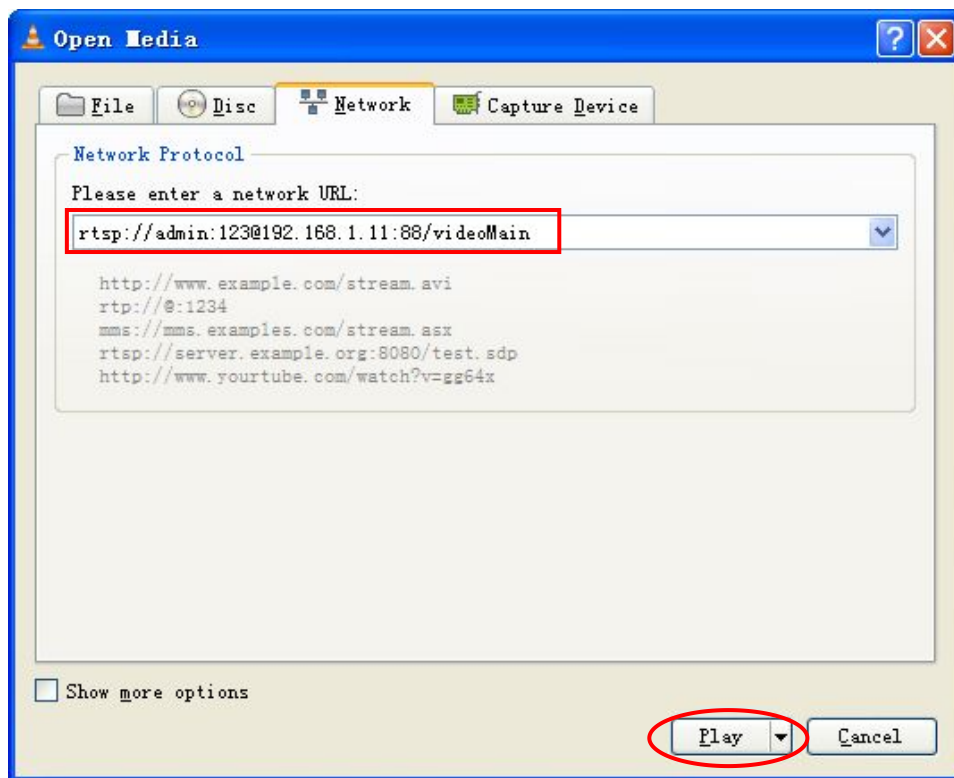

Figure 2.15

Sometimes you may need to enter the user name and password again. Click OK and you can see the real-time preview.



Figure 2.16

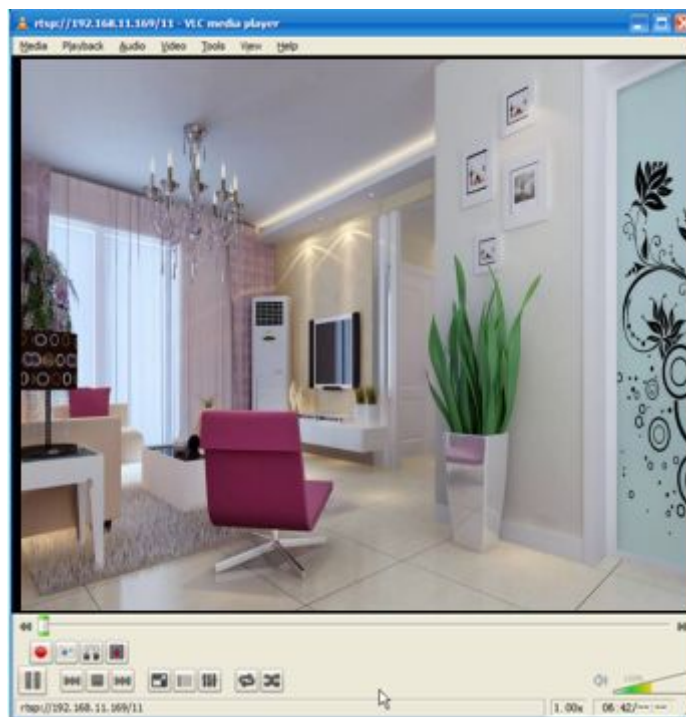

Figure 2.17

If you cannot play the video in the VLC player, please check the port mapping. You can read Quick Installation Guide about How to configure port forwarding.

NOTE:

If you modify the camera's username or password, you had better reboot the camera, or else the new username and password cannot take effect when you enter the authentication in the VLC.

2.5 IP camera connection to the server

Device supports ONVIF 2.2.1 protocol, You can easily access the NVR with ONVIF or server with ONVIF.

3 Surveillance Software GUI

Please refer to the section 2.1 if you install the camera for the first time. You can start to learn about software operation after finish quick installation.

3.1 Login Window

The screenshot shows a login window with the following elements:

- 1**: Username field containing 'admin' and an empty Password field.
- 2**: Stream dropdown menu set to 'Main stream'.
- 3**: Language dropdown menu set to 'English'.
- 4**: Login button.

Figure 3.1

Section1 Enter the Username and password

The default administrator username is admin with no password, please change the password at first using and prevent unauthorized users login the camera.

Section2 Stream

The camera supports two stream modes: Main stream and sub stream. If you want to access the camera form LAN, here you can select Main stream. If you want to access the camera from Internet, here we recommend sub stream.

Note: When the network bandwidth is bad you'd better select Sub Stream and the video will be more fluent.

Section3 Select the language

You can select the language you need by clicking on the language dropdown list.

Section4 login the camera

Click "Login" button.

NOTE:

When setting up your camera for the first time, it will request that you modify the default username and/or password if both are still set to default. Input the new username and password, click "Modify" to complete the

modification. You will now use the new username and password to login the camera in the future.

Username

New username

New password

Security Level

Confirm the password

Modify

Figure 3.2

After logging in for the first time, you will go to “Setup Wizard” automatically. Here you can set the basic parameters of camera, such as camera name, camera time, wireless settings, IP configuration.

Setup Wizard

Setup Wizard

Status

Basic Settings

Network

Video

Alarm

Setup Wizard

Setup Wizard - Start

Follow the guide to set your camera, click "Next" to start.

Please click the menu on the left for more settings.

Next

Figure 3.3

Device Name: You could give name for your camera.

Setup Wizard

Step 1 of 4 - Camera Name

Camera Name

The maximum Device Name length is 20, support English, numbers, letters and symbols

Previous **Next**

Figure 3.4

System Time: Select the time zone you need to set the date, time, format, etc.

Setup Wizard

Step 2 of 4 - Camera Time

Time Zone	<input style="width: 90%;" type="text" value="(GMT) Greenwich mean time; London, Lisbon, "/>		
Sync with NTP server	<input checked="" type="checkbox"/>		
NTP Server	<input style="width: 90%;" type="text" value="time.nist.gov"/>		
PC Time	<input style="width: 15%;" type="text" value="2014-1-1"/>	<input style="width: 10%;" type="text" value="12"/>	<input style="width: 10%;" type="text" value="17"/>
		<input style="width: 10%;" type="text" value="29"/>	<input style="width: 10%;" type="text" value="PM"/>
	<input type="button" value="Sync with PC"/>		
Date Format	<input style="width: 90%;" type="text" value="YYYY-MM-DD"/>		
Time Format	<input style="width: 90%;" type="text" value="12-hour"/>		
use DST	<input type="checkbox"/>		
Ahead Of Time	<input style="width: 10%;" type="text" value="0"/>	Minute	
<input type="button" value="Previous"/>		<input type="button" value="Next"/>	

Figure 3.5

Wireless networks: Click “Scan”, find the SSID of your wireless router, select and enter the password.

Setup Wizard

Step 3 of 4 - Wireless Settings

Wireless Network List			1
SSID(Network Name)	Encryption	Quality	
Tenda_373678	WPA/WPA2		<div style="text-align: center;">3</div>
dlink-chenchen2.4G	WPA/WPA2		
TP_LINK_TEST	WPA2		
FOSCAM-docdev	WPA/WPA2		

SSID	<input style="width: 80%;" type="text" value="FOSCAM-docdev"/>
Encryption	<input style="width: 80%;" type="text" value="WPA/WPA2"/>
Password	<input style="width: 80%;" type="text" value="....."/>

The maximum password length is 63, including numbers, letters and symbols

Figure 3.6

IP: Set IP address of the camera. You could choose to obtain an IP automatically or set the IP address according to your needs.

Setup Wizard

Step 4 of 4 - IP Configuration

Obtain IP From DHCP

IP Address	192.168.1.101
Subnet Mask	255.255.255.0
Gateway	0.0.0.0
Primary DNS Server	0.0.0.0
Secondary DNS Server	0.0.0.0

Note: Once you save your settings, the camera will restart.

Figure 3.7

NOTE:

It needs about 1 minute to connect the camera to your router.

3.2 Surveillance Window



Figure 3.8

Differences					
Model	Playback	HDR	Pan/Tilt control	Zoom out/ Zoom in	Cruise
FI9804W	x	x	x	x	x
FI9805W	x	x	x	x	x
FI9805E	x	x	√	x	√
FI9803EP	√	x	x	x	x
FI9803P	x	x	x	x	x
FI9903P	x	x	x	x	x
FI9900P	√	√	x	√	x
FI9900EP	√	√	x	√	x
FI9800P	x	x	x	x	x
FI9901EP	√	√	x	√	x

Section1 FOSCAM Logo/ LiveVideo / Settings buttons

: FOSCAM LOGO

: Path to surveillance window. Click this button and back to the surveillance window

: Path to Administrator Control Panel, Click it, and it will lead to Administrator Control Panel and do advanced settings.

Section2 Multi-Device Window



The firmware inside the camera supports up to maximum of 9 cameras being monitoring at the same time. You can add other cameras in multi-camera panel.

Section3 Mode/ Stream / Mirror/ Flip buttons

Mode

- 1) 50Hz -----Indoor surveillance (Region: Europe, China)
- 2) 60Hz -----Indoor surveillance (Region: USA, Canada)
- 3) Outdoor Mode-----Outdoor surveillance

Stream

The default stream supports multiple modes, For example: HD Mode/720P/30fps/2M meanings: **Stream type / Resolution / Maximum frame rate/ Bit rate**. (Different models support different specific mode.)

1) **Stream type no.** : Identify the stream type.

2) Resolution

The bigger the resolution, the better of the image quality is. If you are accessing the camera via internet and want to get more fluent video streaming, please select resolution VGA.

3) Maximum frame rate

The maximum frame rate is 30 fps. You should lower frame rate when the bandwidth is limited. Normally, when the frame rate above 15, you can achieve fluently video. The maximum frame rate for each model is different,

please see the “Specifications” .

4) Bit rate

Generally speaking, the larger the bit rate is, the clearer video will become. But the bit rate configuration should combine well with the network bandwidth. When the bandwidth is very narrow, and bit rate is large, that will lead to video cannot play well.

You can reset the stream type on “Settings-> Video-> Video Settings” panel.

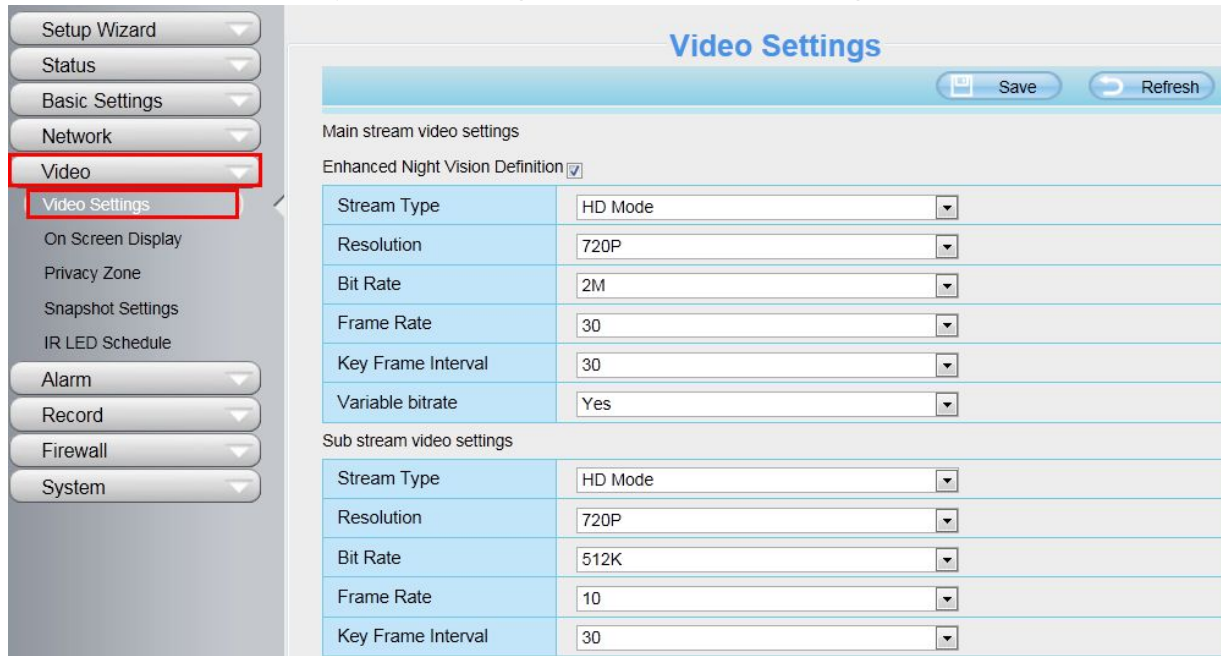



Figure 3.10

HDR(Only FI9900P,FI9900EP, FI9901EP): HDR stands for High Dynamic Range. It usually refers to the method of capturing images having “greater dynamic range between the lightest and darkest areas of an image than current standard digital imaging methods or photographic methods”. You can select “on” from the dropdown list under sunlight or with bright background.

“Zoom in” or “Zoom out”(FI9900P, FI9900EP, FI9901EP)

Device Support 8x zoom feature, click  or  ,The focal length of the camera lens will be larger or shrink, you can adjust the focus distance to the target object size, access to high-definition screen.

Section4 Pan/Tilt Control(only F9805E)

When via RS485 interface to connect an external PTZ device, you can use this feature.

1



1-----Up control button,
3-----Left control button,

2-----Down control button,
4-----Right control button,



Click this button and go to center

Section5 Cruise settings (only F9805E)

If via RS485 interface to connect an external PT device, you can use this feature.



The default cruise tracks have two types: Vertical and Horizontal.

Vertical: The camera will rotate from up to down.

Horizontal: The camera will rotate from left to right.



: Start cruise.



: Stop cruise.

If you want to define or change the cruise trace, please go to **Settings**→ **PTZ**→ **Preset Settings** panel.

How to do cruise?

Firstly: Select one track in the track drop-down list

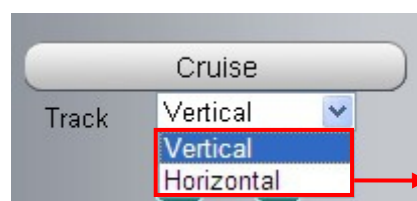

Select one of these

Secondly: Click Start cruise button, the camera will cruise following the predefined path.

Thirdly: Click stop button and finish cruising.

Section6 IR LED Lights

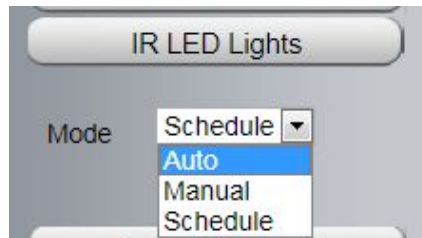

Click Infra led and there are three modes to adjust the infrared led: Auto, Manual and Schedule.

Auto: Select it and the camera will adjust the infra led (on or off) automatically.

Manual: Select it and turn off the infra led manually.

Schedule: Select it and the IR led light will be off at the schedule period. If you want to define or change the IR led lights schedule time, please go to **Settings**→**Video**→**IR LED Schedule** page.

Section7 Image quality settings

In this page, you can tune Hue, Brightness, Contrast, Saturation, and Sharpness to get higher quality.



Section8 OSD

If you have added time and camera name in the video, you can see it in the live window.

Go to **Settings** ---**Basic settings**---**Camera name** panel, and you can change another device name. The default device name is anonymous.

Go to **Settings** ---**Basic settings**---**Camera time** panel and adjust the device time.

Go to **Settings** ---**Video**---**On Screen Display** panel, you can add or no add OSD.

Section9 Play/Stop/ Talk/Audio/ Snap/ Record/ Full screen button





1-----Play Click it to play the video of the camera



5 6 7

2-----Stop Click it to stop the video of the camera

3----- Talk: Click the button and the icon will become to , then talk to the microphone that connected with PC, people around the camera can hear your voice if the camera has connected with audio output device. Click the icon again and stop talking.

4----- Audio Click the button and the icon will become to , you can hear the sound around the camera if the camera has connected with other audio input device through the Audio Input port of the camera, Click the icon again and stop audio.

5----- Snap: Click it to make snapshot and it pop up a window which picture you snapshot, right click in the window and save the picture to anywhere you want.

6----- Record: Click the icon  and the camera start recording, you can see a green dot in the live window. Click again and stop recording. The default storage path is C:\IPCcamRecord. You can change the storage path: Go to Settings- >Record-> Storage Location panel.

7-----Full Screen Click it to make full-screen, or you can double click the surveillance screen to make full-screen. Double click again and exit full-screen.

Onscreen Mouse Control

Right click the mouse and you can adjust the screen ration, full screen and Zoom up.



Figure 3.11

Keep ration: Select it and the camera will adjust the size of live window based on the computer monitor automatically.

Sometimes there is a black border around the video, please select Keep ration to get a better visual quality.



Figure 3.12

Full Screen: Select it and Click it to make full-screen, press ESC and exit full-screen.

Zoom up/down: Click it and the live view will be digital zoomed up, then click Zoom Down and the live view back to original size.



Figure 3.13

NOTES:

1 This camera don't support Pan/Tilt function, so here can't allow to use Screen PTZ.

2 For Mac OS, the plugin cannot support Onscreen Mouse function, so you cannot allow to use it.

4 Advanced Camera Settings

Click the button "Settings", goes to Administrator Control Panel to make advanced camera settings.

4.1 Setup Wizard

The way to set it, you could refer to section 3.1.

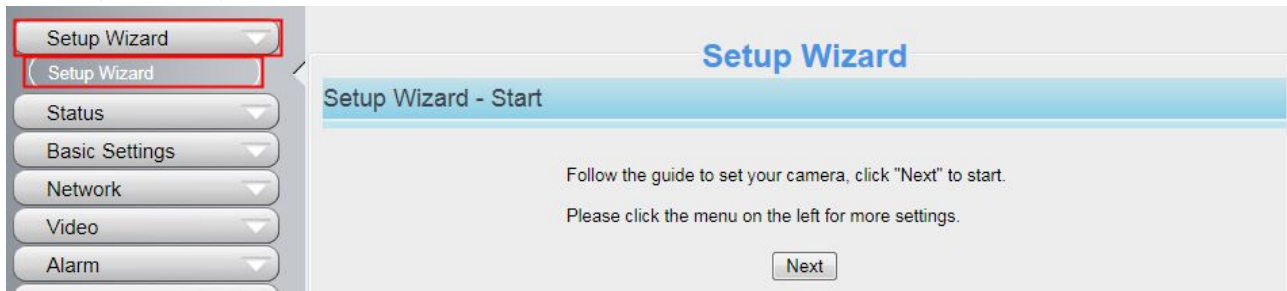

Figure 4.1

4.2 Device Status

Device Status contains four columns: Device Information, Device Status, Session Status and Log, it will show you various information about your camera.

4.2.1 Device Information

Refresh	
Camera Model	F19804W
Camera Name	anonymous
Camera ID	00841F19804W
Camera Time	2013/10/21 16:12:07
System Firmware Version	1.4.1.7
Application Firmware Version	1.14.1.20
Plug-In Version	2.0.1.6

Figure 4.2

Camera Model: The model of the device.

Camera Name: The Device Name is a unique name that you can give to your device to help you identify it. Click Basic Settings and go to Device Name panel where you can change your camera name. The default device name is anonymous.

Camera ID: Display the MAC address of your camera. For example Device ID is 008414350787, the same

MAC ID sticker is found at the bottom of the camera.

Camera Time: The system time of the device. Click Basic Settings and go to Camera Time panel and adjust the time.

System Firmware Version: Display the System Firmware version of your camera.

Application Firmware Version: Display the application firmware version of your camera.

Plug-In Version: Display the plug-in version of your camera

4.2.2 Device Status

On this page you can see device status such as Alarm status, NTP/DDNS status, WIFI status and so on.



		Refresh
Alarm Status	Disabled	
NTP Status	Disable	
DDNS Status	Disable	
UPnP Status	Success	
WiFi Status	Not connected	
IR LED Status	Off	

Figure 4.3

4.2.3 Session status

Session status will display who and which IP is visiting the camera now.

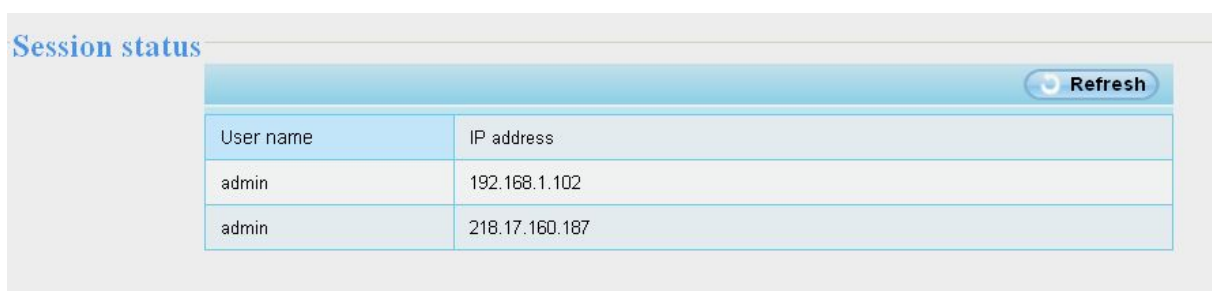

		Refresh
User name	IP address	
admin	192.168.1.102	
admin	218.17.160.187	

Figure 4.4

4.2.4 Log

The log record shows who and which IP address accessed or logout the camera and when.

The screenshot shows the 'Log' page in the Foscam web interface. On the left, a sidebar menu has 'Log' selected. The main content area displays a table of log entries. The table has the following columns: NO., Time, User, IP, and Log. The entries are as follows:

NO.	Time	User	IP	Log
1	2014-01-09 14:12:35	root	127.0.0.1	Detected motion alarm
2	2014-01-09 14:12:35	root	127.0.0.1	Detected motion alarm
3	2014-01-09 14:12:35	root	127.0.0.1	Detected motion alarm
4	2014-01-09 14:11:24	foscam	192.168.0.2	User off line
5	2014-01-09 14:11:11	root	127.0.0.1	Detected motion alarm
6	2014-01-09 14:11:11	root	127.0.0.1	Detected motion alarm
7	2014-01-09 14:10:49	root	127.0.0.1	Detected motion alarm
8	2014-01-09 14:10:28	root	127.0.0.1	Detected motion alarm
9	2014-01-09 14:09:41	root	127.0.0.1	Detected motion alarm
10	2014-01-09 14:08:31	root	127.0.0.1	Detected motion alarm

Two red callout boxes provide instructions: 'Click the page number and go to the corresponding page to see more logs.' and 'Fill in one page number, click Go button and go to the corresponding page.'

Figure 4.5

Reboot the camera and clear the log records.

4.3 Basic Settings

This section allows you to configure your Camera Name, Camera Time, Mail, User Accounts and Multi-Device.

4.3.1 Camera Name

Default alias is anonymous. You can define a name for your camera here such as apple. Click **Save** to save your changes. The alias name cannot contain special characters.

The screenshot shows the 'Camera Name' configuration page. The page has a light blue header with 'Save' and 'Refresh' buttons. Below the header, there is a label 'Camera Name' and a text input field containing the value 'anonymous'.

Figure 4.6

4.3.2 Camera Time

This section allows you to configure the settings of the internal system clocks for your camera.

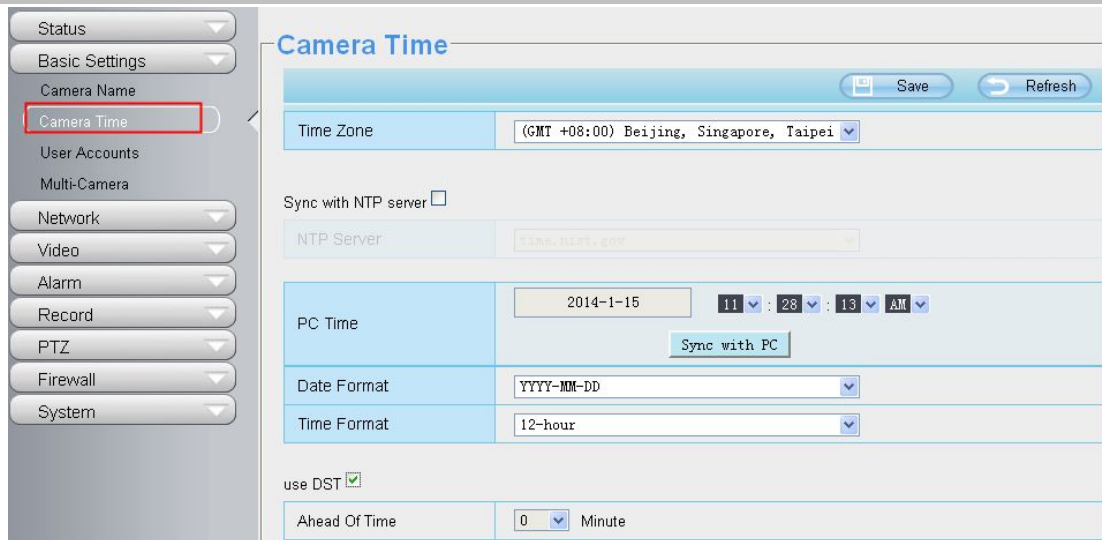

Figure 4.7

Time Zone: Select the time zone for your region from the drop-down menu.

Sync with NTP server: Network Time Protocol will synchronize your camera with an Internet time server. Choose the one that is closest to your camera.

Sync with PC: Select this option to synchronize the date and time of the Network Camera with your computer.

Manually: The administrator can enter the date and time manually. Please select the date and time format.

use DST: Select the **use DST**, then select the daylight saving time from the drop-down menu.

Click Save button to submit your settings.

NOTE: If the power supply of camera is disconnect, you need set the camera's time again.

4.3.3 User Accounts

Here you can create users and set privilege, **visitor**, **operator** or **administrator**. The default administrator user accounts are admin with a blank password.

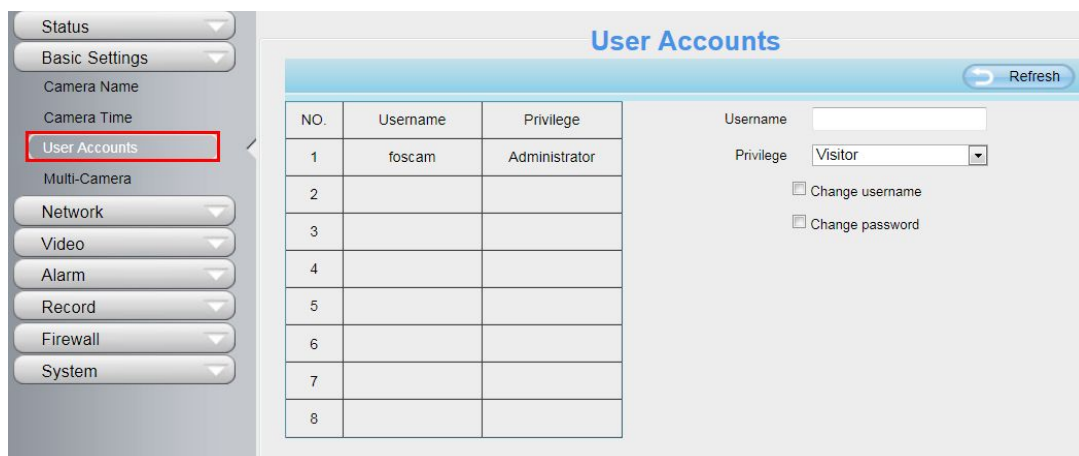

Figure 4.8

How to change the password?

Firstly, select the account which you want to change the password, then select "Change password", enter the

old password and the new password, lastly click modify to take effect.

The screenshot shows the 'User Accounts' management page. On the left is a table with columns 'NO.', 'Username', and 'Privilege'. The first row (NO. 1) is highlighted in green and contains 'foscam' and 'Administrator'. To the right is a form for modifying the selected user. The 'Username' field contains 'foscam'. The 'Password' field is empty. The 'New password' field is empty. The 'Security Level' is a progress bar. The 'Confirm the password' field is empty. The 'Privilege' dropdown menu is set to 'Administrator'. There are checkboxes for 'Change username' (unchecked) and 'Change password' (checked). A 'Modify' button is at the bottom of the form. Below the form, there is a note: 'The maximum username length is 20, including numbers, letters and symbols _ - @ \$ *' and 'The maximum password length is 12, including numbers, letters and symbols ~ ! @ # % ^ * () _ + { } : " | < > ? ` - ; ' \ , . /'.

NO.	Username	Privilege
1	foscam	Administrator
2		
3		
4		
5		
6		
7		
8		

Username: foscam
 Password:
 New password:
 Security Level:
 Confirm the password:
 Privilege: Administrator
 Change username
 Change password
 Modify

The maximum username length is 20, including numbers, letters and symbols _ - @ \$ *
 The maximum password length is 12, including numbers, letters and symbols ~ ! @ # % ^ * () _ + { } : " | < > ? ` - ; ' \ , . /

Figure 4.9

How to add account ?

Select one blank column, then enter the new user name, password and privilege, last click Add to take effect. You can see the new added account on the Account list.

The screenshot shows the 'User Accounts' management page. On the left is a table with columns 'NO.', 'Username', and 'Privilege'. The first row (NO. 1) contains 'foscam' and 'Administrator'. The second row (NO. 2) is highlighted in green and is currently blank. To the right is a form for adding a new user. The 'Username' field contains 'test'. The 'Password' field is filled with dots. The 'Security Level' is a progress bar that is partially filled with green. The 'Confirm the password' field is filled with dots. The 'Privilege' dropdown menu is set to 'Visitor'. There are checkboxes for 'Change username' (unchecked) and 'Change password' (unchecked). An 'Add' button is at the bottom of the form. Below the form, there is a note: 'The maximum username length is 20, including numbers, letters and symbols _ - @ \$ *' and 'The maximum password length is 12, including numbers, letters and symbols ~ ! @ # % ^ * () _ + { } : " | < > ? ` - ; ' \ , . /'.

NO.	Username	Privilege
1	foscam	Administrator
2		
3		
4		
5		
6		
7		
8		

Username: test
 Password:
 Security Level:
 Confirm the password:
 Privilege: Visitor
 Change username
 Change password
 Add

The maximum username length is 20, including numbers, letters and symbols _ - @ \$ *
 The maximum password length is 12, including numbers, letters and symbols ~ ! @ # % ^ * () _ + { } : " | < > ? ` - ; ' \ , . /

Figure 4.10

User Accounts

NO.	Username	Privilege
1	foscam	Administrator
2	test	Visitor
3		
4		
5		
6		
7		
8		

Username:

Privilege:

Change username

Change password

The maximum username length is 20, including numbers, letters and symbols _ - @ \$ *
 The maximum password length is 12, including numbers, letters and symbols ~ ! @ # % ^ * () _ + { } : " | < > ? ` - ; ' \ , . /

Figure 4.11

Delete: Select the account which you want to delete, then click Delete button to take effect.

NOTE:

The default administrator account cannot be deleted, but you can add other administrator users.

4.3.4 Multi-Camera

If you want to view multi-surveillance screens on one window, you need to login one camera, and set it as the main device, and do Multi-Device Settings, add other cameras to the first one camera. Before you do multi-cams settings, you need to assign different port such as 81, 82, 83, 84, 85, 86, 87, 88 to the cameras if there is 8 cams installed.

The firmware within the camera can support a maximum of 9 devices monitoring all at the same time. This page you can both add FOSCAM MJPEG and H.264 series cameras to the first camera and view multi-surveillance screen on one window.

Add cameras in LAN

In Multi-Device Settings page, you can see all devices searched in LAN. The 1st Device is the default one. You can add more cameras in the list in LAN for monitoring. The camera's software supports up to 9 IP Cameras online simultaneously. Click The **2nd Device** and click the item in the Device List in LAN, the Alias, Host and Http Port will be filled in the boxes below automatically. Enter the correct username and password then click **Add**. Add more cameras in the same way.

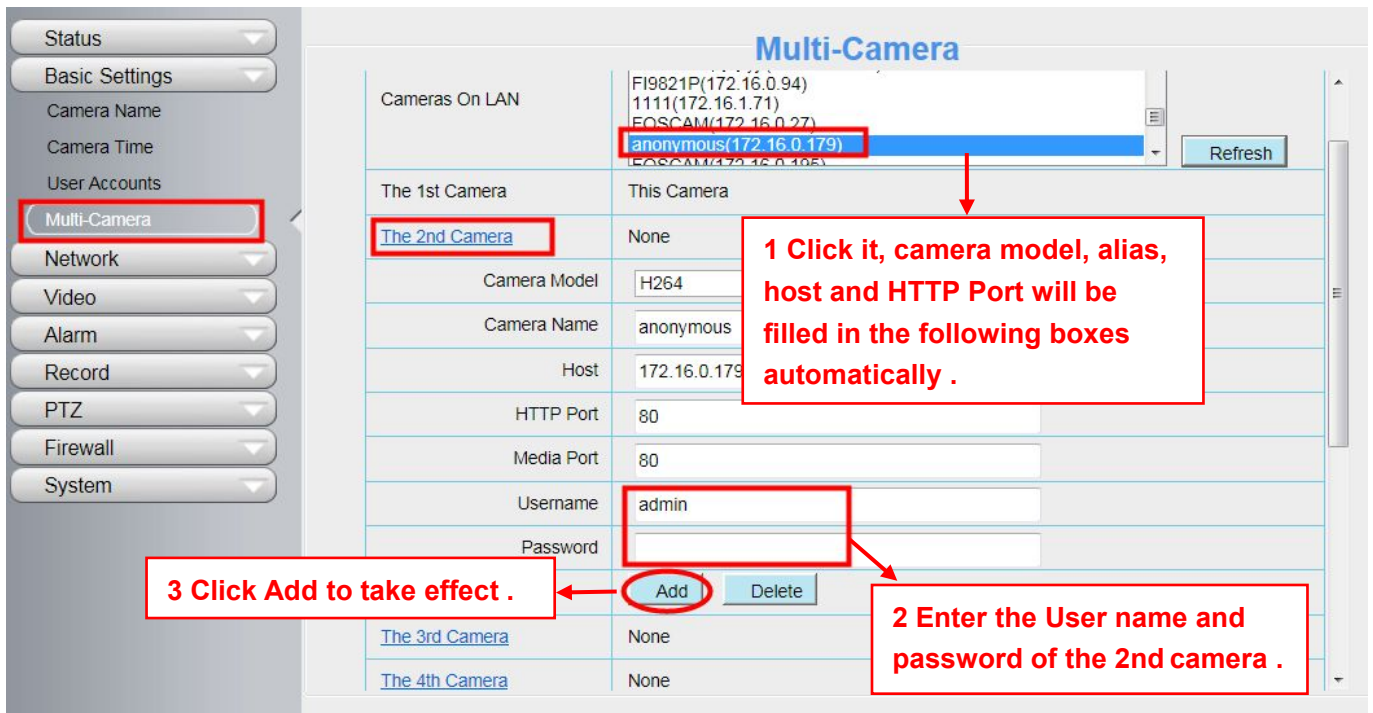

Figure 4.12

Camera Model: Our Company produces two series cameras: MJPEG and H.264. Here will show you which series the camera belongs to.

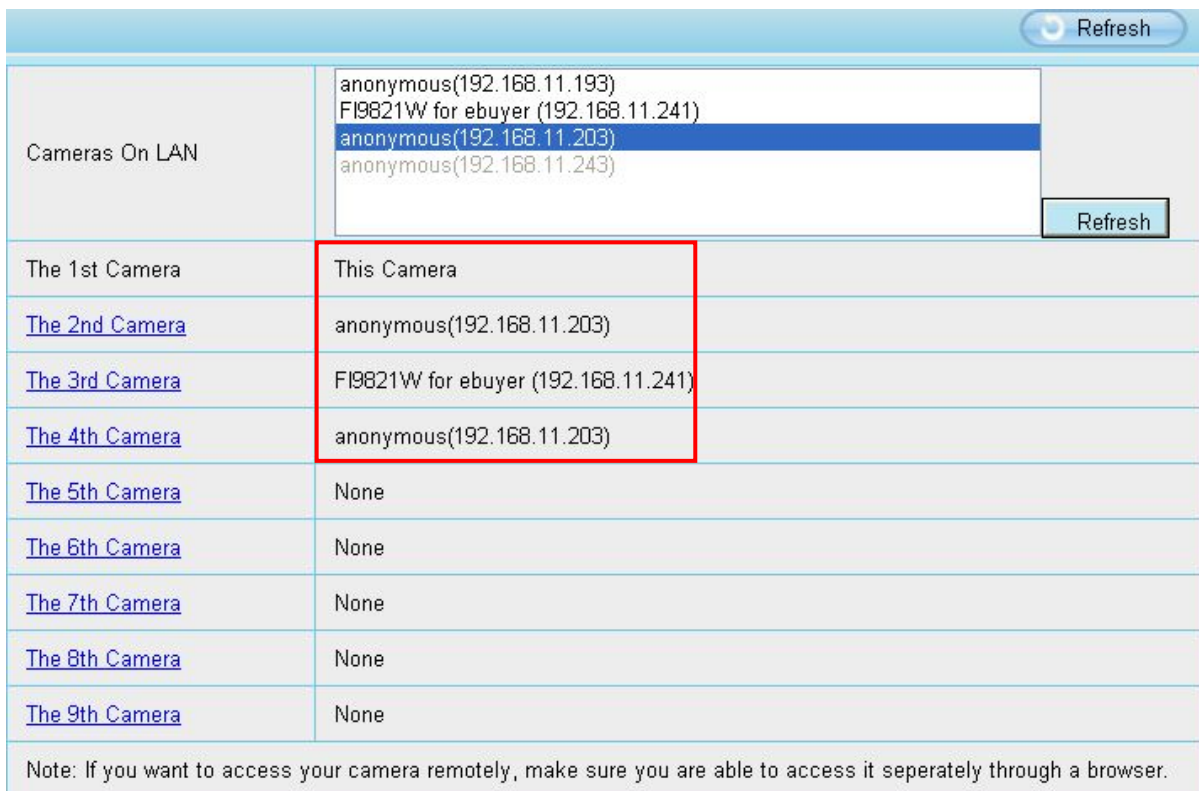

Figure 4.13

Back to Surveillance Windows, and click Four Windows option, you will see four cameras you added.

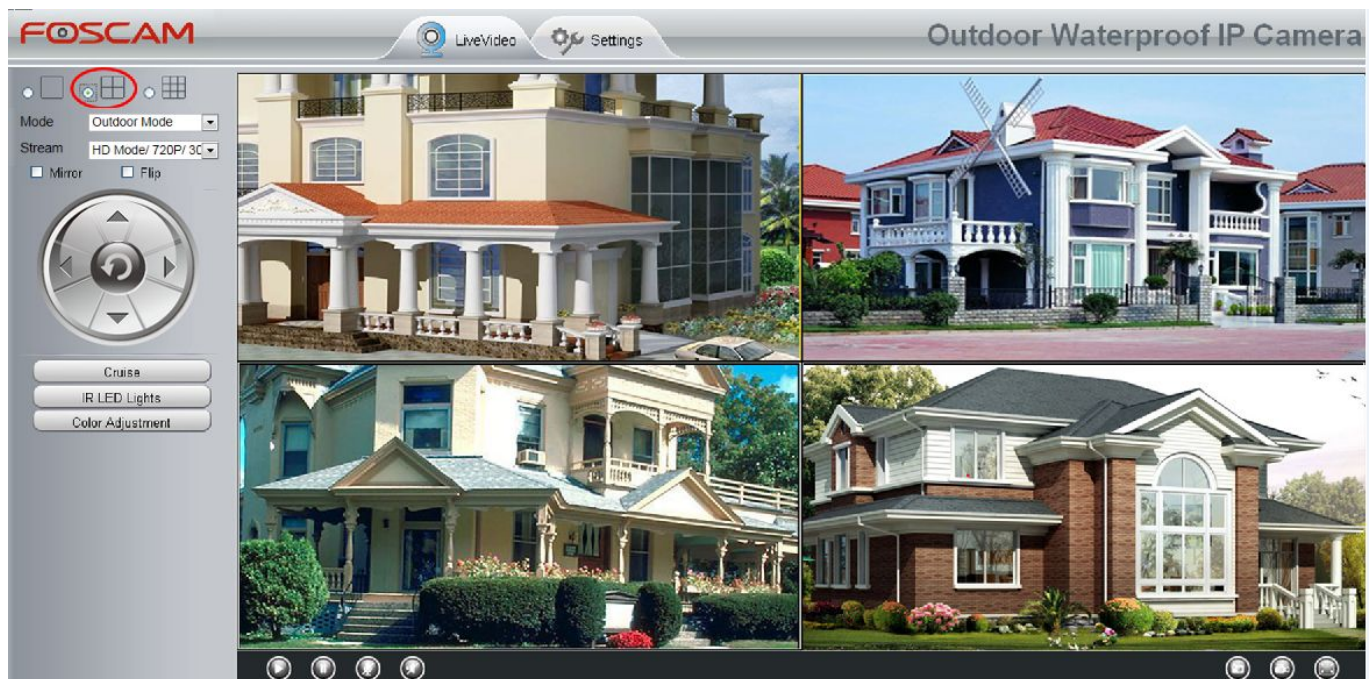

Figure 4.14

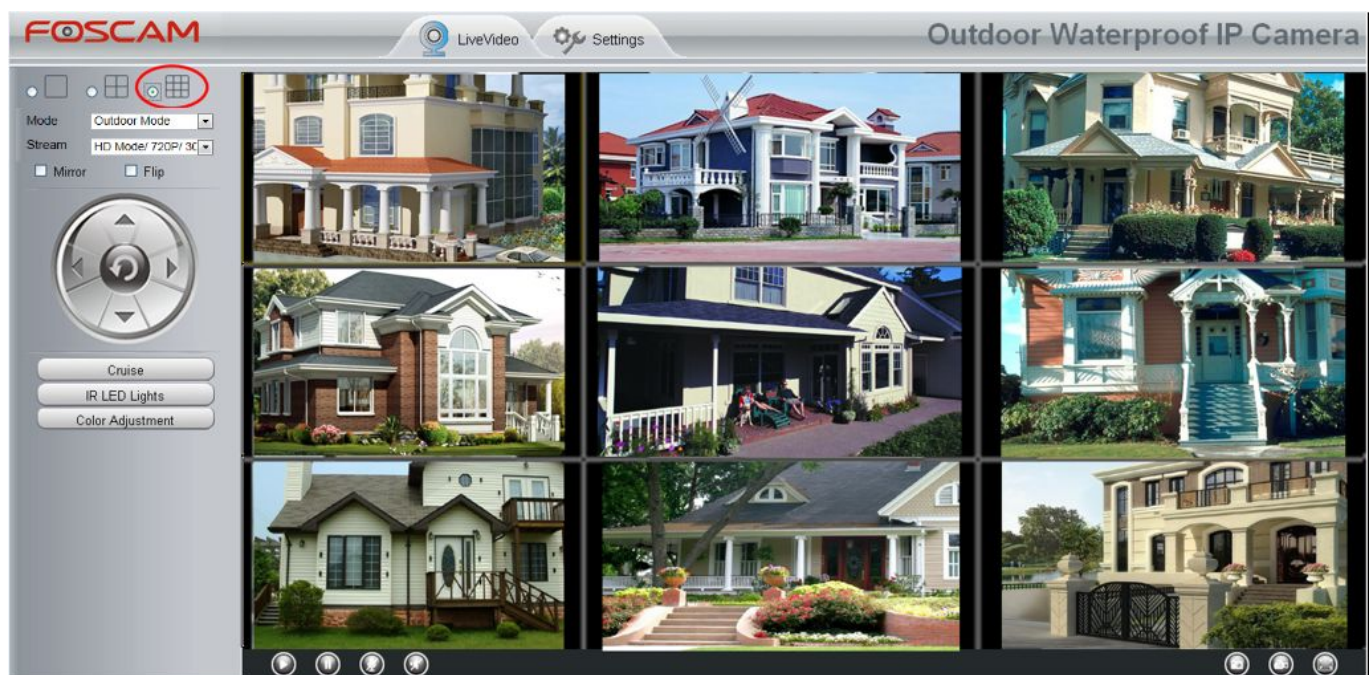

Figure 4.15

Add cameras in WAN

If you want to view all cameras via the internet(remote computer), you will need to add them using DDNS domain name. Firstly, make sure all of the cameras you added can be accessed through the internet. (Read How to configure DDNS settings in chapter 4.4.4)

Login to the first camera using a DDNS domain name and port.

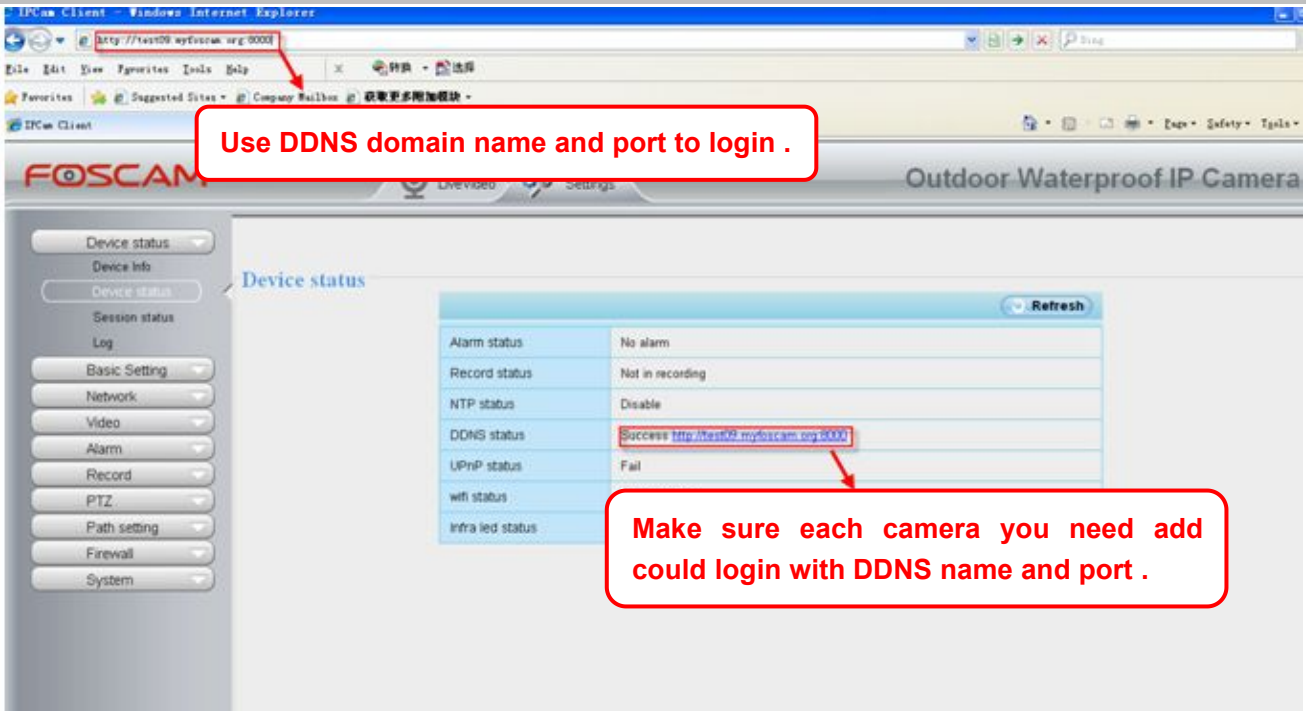

Figure 4.16

Click Multi-Device Settings. Choose The 2nd Device. Fill in the 2nd camera's name, DDNS domain name, port number. Enter user name and password and then choose Add.

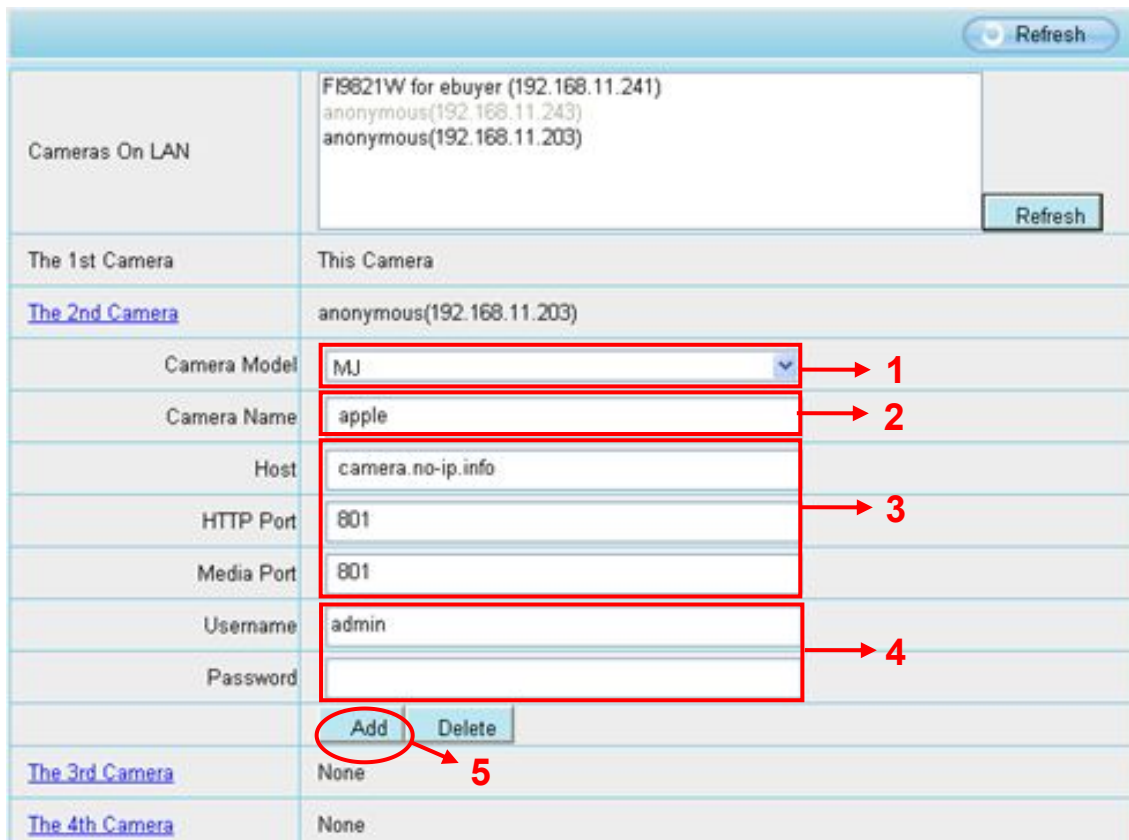

Figure 4.17

- 1----- The camera model: MJ or H264.
- 2----- The 2nd camera's name

- 3----- Fill in the 2nd camera's DDNS host not LAN IP
 4 ---- Enter the 2nd camera's user name and password
 5---- Click Add button and to take effect

NOTE: Here the Host must be entered as the second camera's DDNS domain name, not its LAN IP.

Refresh	
Device List in LAN	apple(192.168.13.102) mycamera(192.168.13.108) ipcam(192.168.13.107) FI9821W-01(192.168.13.106) <div style="text-align: right;">Refresh</div>
The 1st Device	This Device
The 2nd Device	apple(camera.no-ip.info)
The 3rd Device	ipcam(test01.foscam.org)
The 4th Device	mycamera(owlejwww.no-ip.info)
The 5th Device	None
The 6th Device	None
The 7th Device	None
The 8th Device	None
The 9th Device	None
Attention: If you want to access the device from internet, be sure the host and port that you set can be accessed from internet.	

Figure 4.18

Return to video window. You will see all of the cameras accessible through the internet.

When you are away from home, you can use the first camera's DDNS domain name and port to view all the cameras via internet.

4.4 Network

This section will allow you to configure your camera's IP, PPOE, DDNS, Wireless Settings, UPnP, Port, Mail Settings and FTP Settings.

4.4.1 IP Configuration

If you want to set a static IP for the camera, please go to **IP Configuration** page. Keep the camera in the same subnet of your router or computer.

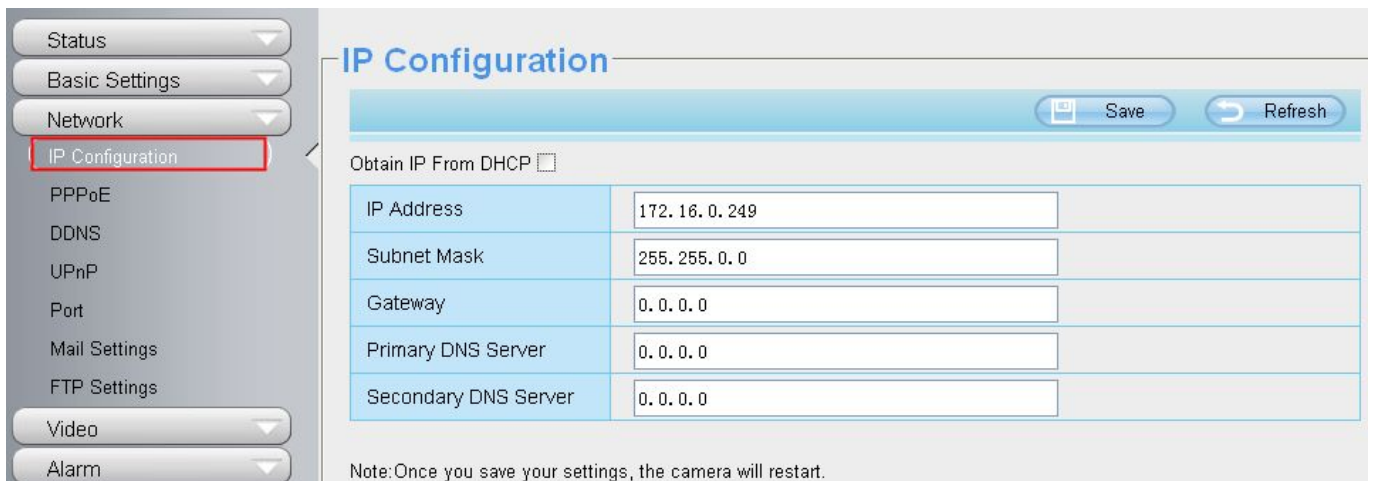

Figure 4.19

Changing settings here is the same as using the Equipment Search Tool.

It is recommended that you use the subnet mask, gateway and DNS server from your locally attached PC. If you don't know the subnet mask, gateway and DNS server, you can check your computer's local area connection as follows:

Control Panel--Network Connections--Local Area Connections --Choose Support--Details.

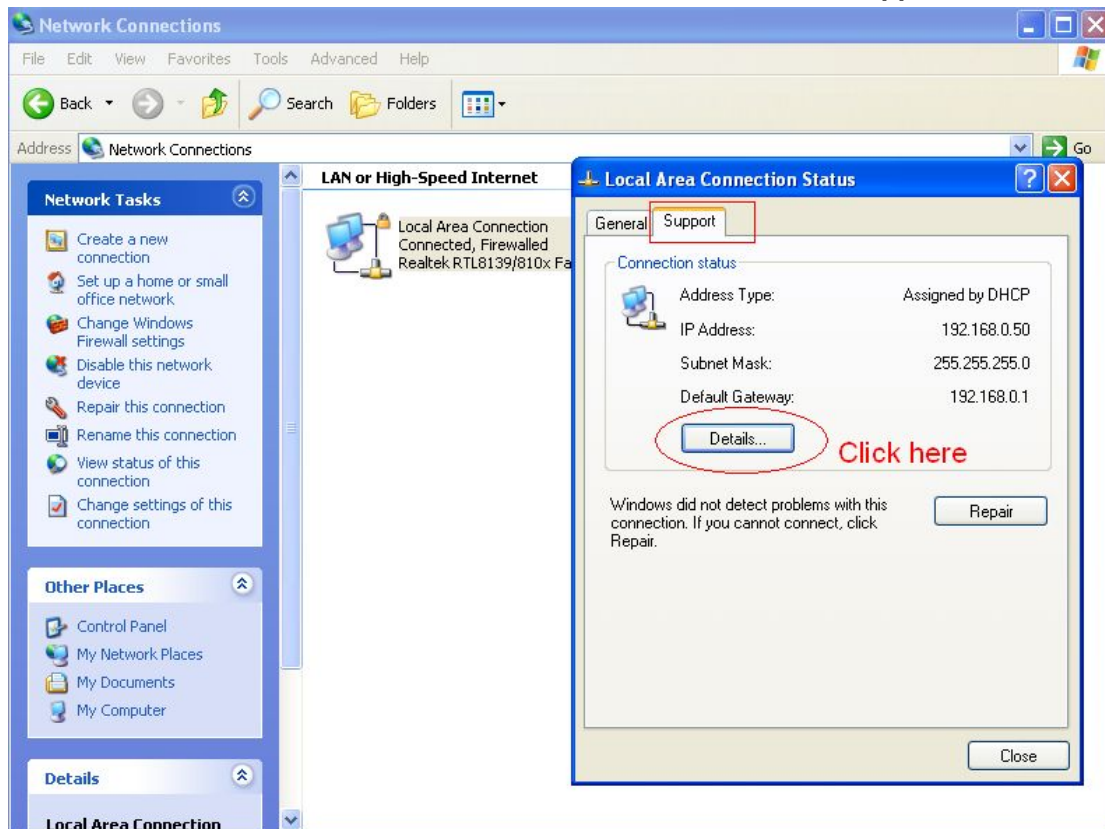

Figure 4.20

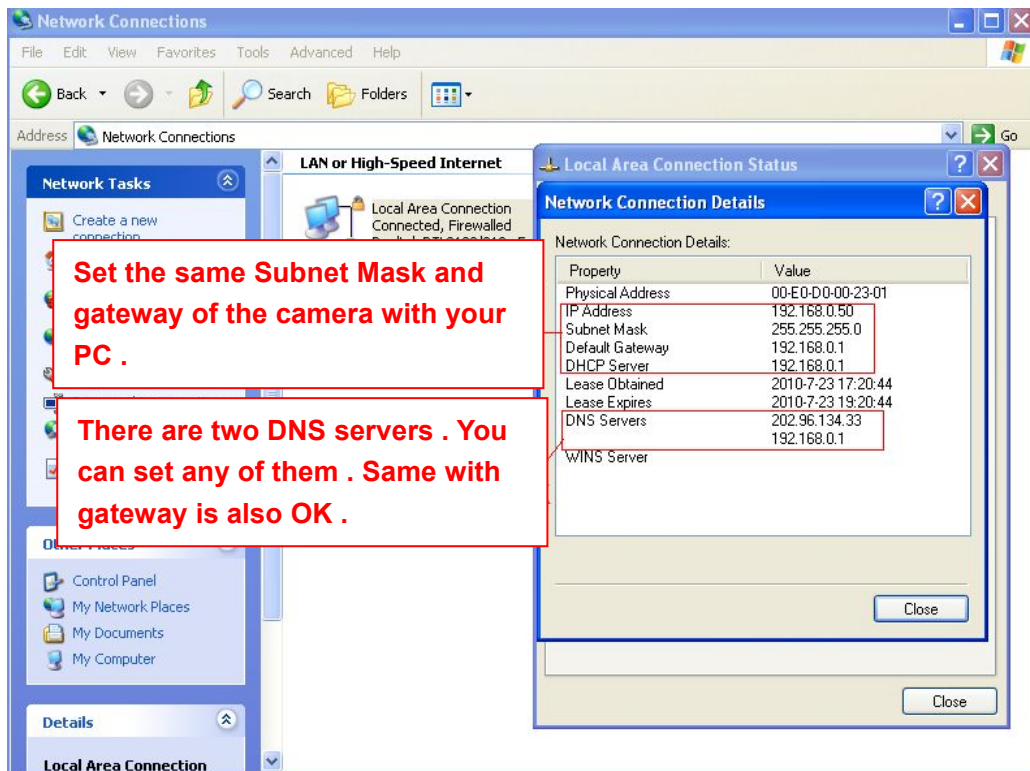

Figure 4.21

If you don't know the DNS server, you can use the same settings as the Default Gateway.

4.4.2 Wireless Settings(FI9803P/FI9804W/FI9805W/FI9900P/FI9800P)

Step 1: Choose "Settings" on the top of the camera interface, and go to the "Network" panel on the left side of the screen, then click "Wireless Settings."

Click the Scan button and the camera will detect all wireless networks around the area. It should also display your router in the list.

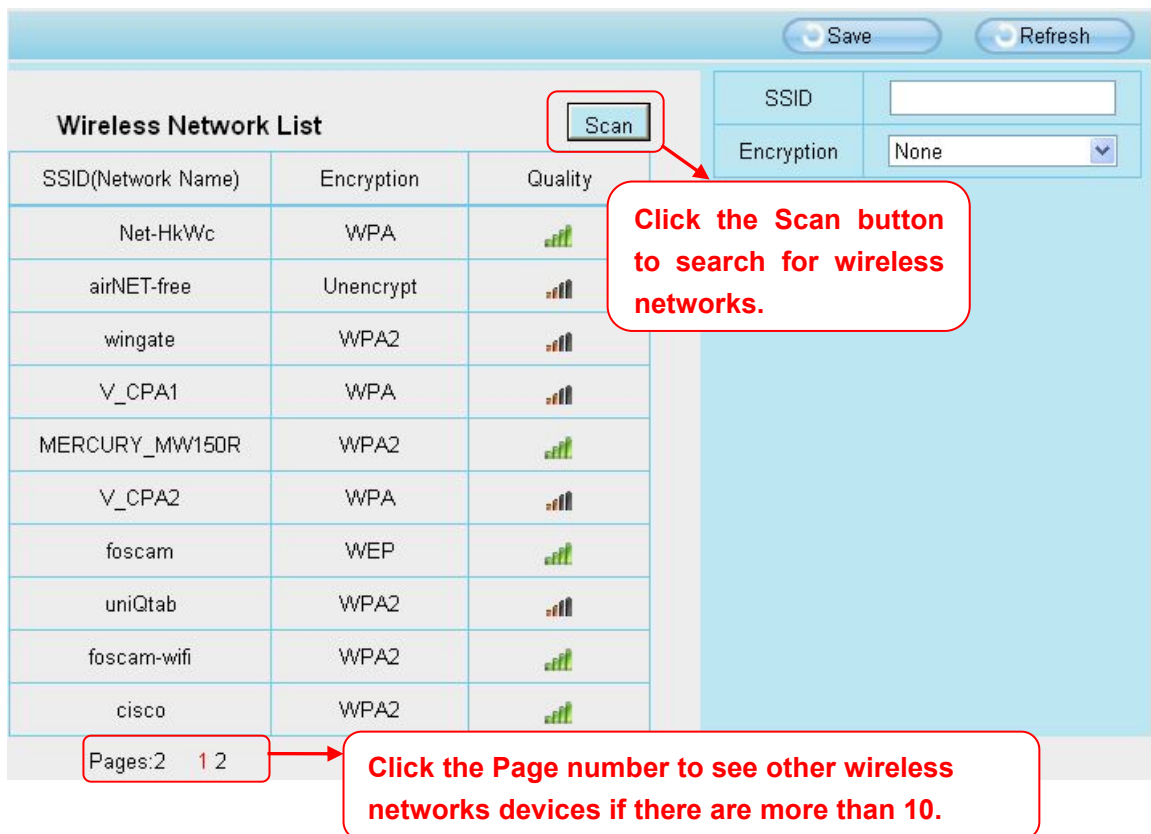

Figure 4.22

Step 2: Click the SSID (name of your router) in the list, the corresponding information related to your network, such as the name and the encryption, will be filled into the relevant fields automatically.

You will only need to fill in the password of your network. Make sure that the SSID, Encryption and the password you filled in are exactly the same for your router.

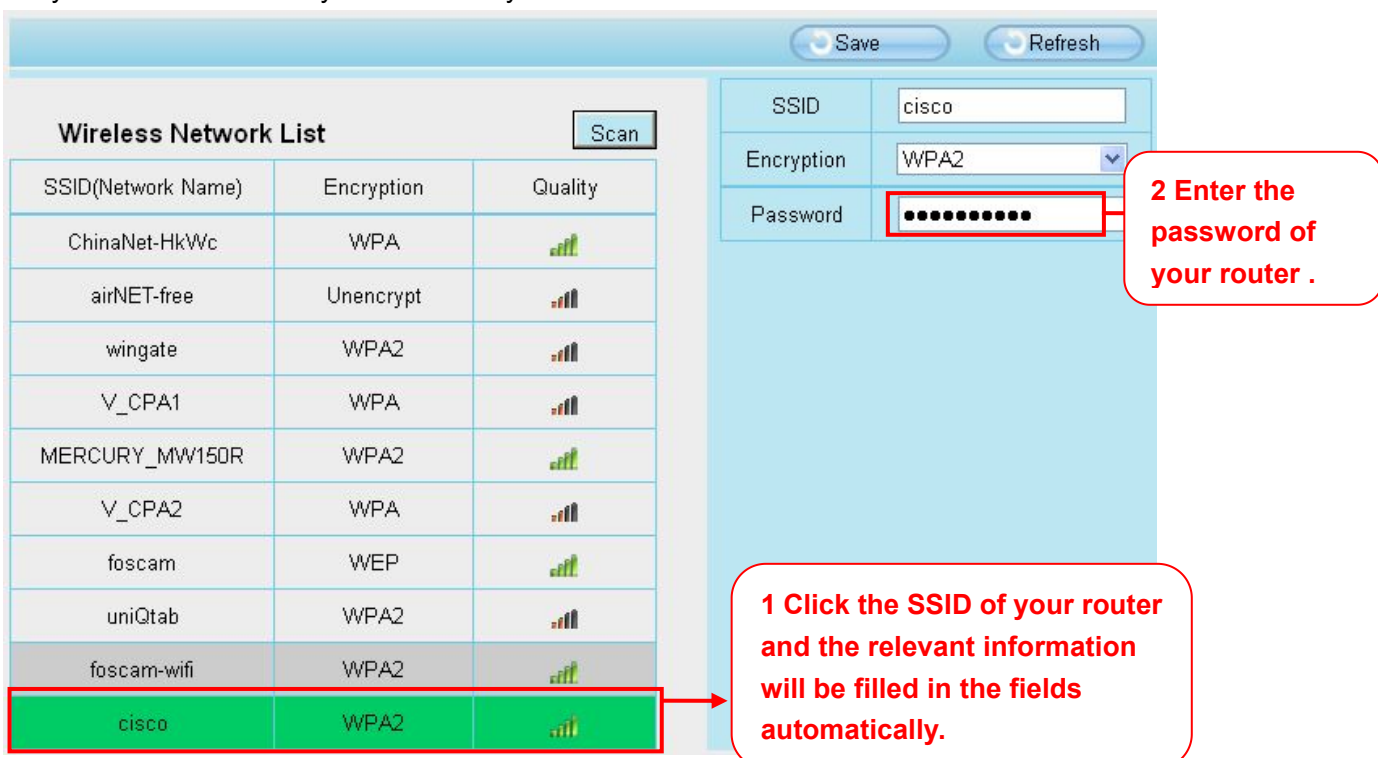

Figure 4.23

Step 3: Please click on the Save button after all settings have been entered and disconnect the network cable. Never shut down the power of the camera until the IP camera is able to connect to the wireless network.

The LAN IP address will disappear on the window of Equipment Search Tool when the camera is configuring a wireless connection. Wait about 1 minute, the camera should obtain a wireless connection, and the LAN IP of the camera will show again on the window of the Equipment Search Tool. The IP address may have changed after the camera receives a wireless connection; we recommend setting a static local IP address if this IP address changes by right clicking the camera in Equipment Search Tool, setting a static IP, and pushing OK. Congratulations! You have set up the wireless connection of the camera successfully.

NOTE :

If you fail to make a wireless connection, please refer to your seller or contact us directly for assistance.

4.4.3 PPPoE

Only some models support PPPoE.

If you are using a PPPoE connection, enable it and enter the User Name and Password for your PPPoE account.

Figure 4.24

4.4.4 DDNS

FOSCAM camera has embedded a unique DDNS domain name when producing, and you can directly use the domain name, you can also use the third party domain name.

FOSCAM domain name

Here take **cp4911.myfoscam.org** for example. Go to option of DDNS on the **Settings->Network** panel, you can see the domain name.

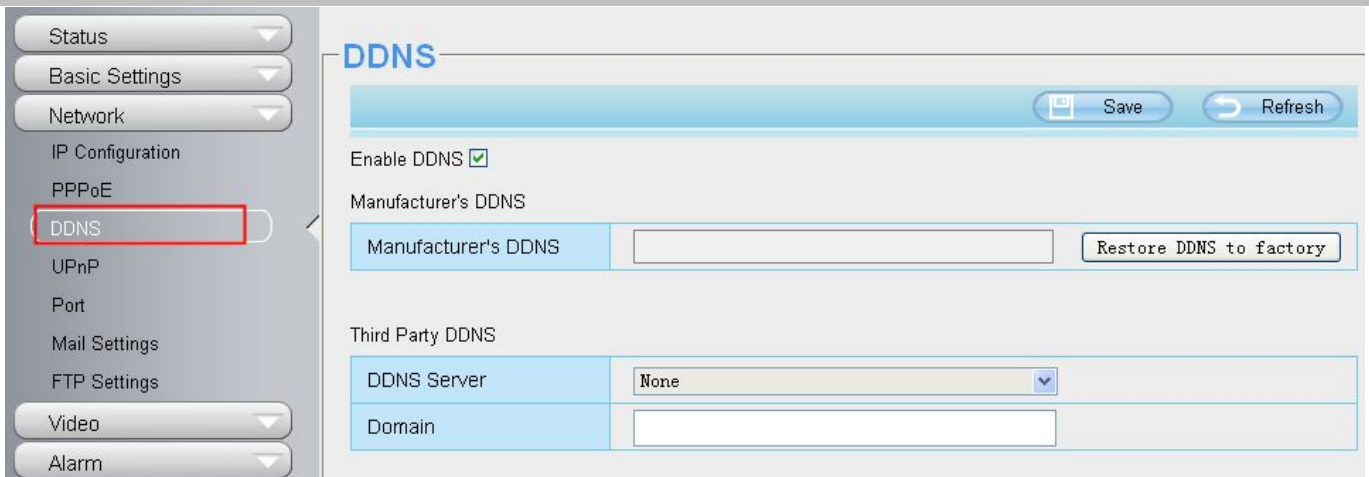

Figure 4.25

Now you can use **http:// Domain name + HTTP Port** to access the camera via internet.

Take hostname **cp4911.myfoscam.org** and HTTP Port no. 8000 for example, the accessing link of the camera via internet would be **http://cp4911.myfoscam.org:8000**

Restore DDNS to factory: If you have configured Third Party DDNS successfully, but you want to use Manufacturer's DDNS again, here click this button and start Manufacturer's DDNS Service.

Third Party Domain Name Settings

User can also use third part DDNS, such as www.no-ip.com, www.3322.com

Here take **www.no-ip.com** for example :

① **Step 1 Go to the website www.no-ip.com to create a free hostname**

Firstly: Login on www.no-ip.com and click No-IP Free to register.



Figure 4.26

Please register an account step by step according to instructions on www.no-ip.com

After registration, please login your email which used to register. You will receive an email from website, please click the link to activate your ACCOUNT as indicated in email.

Secondly: Login the link with the registered username and password to create your domain name.

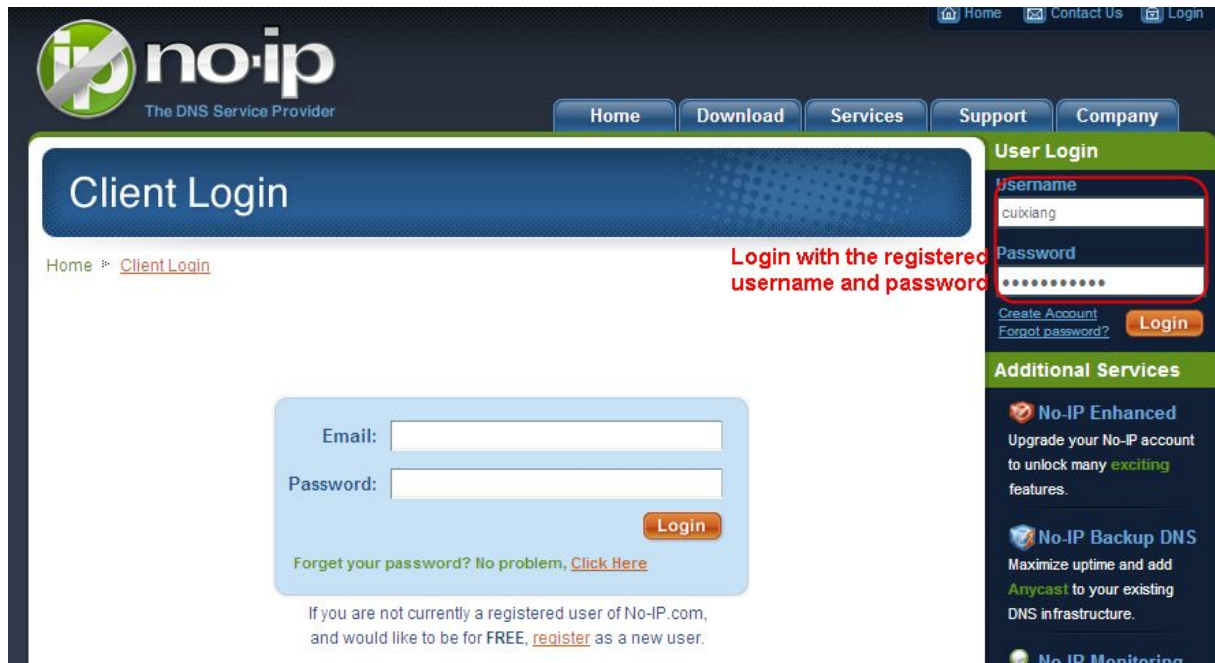

Figure 4.27

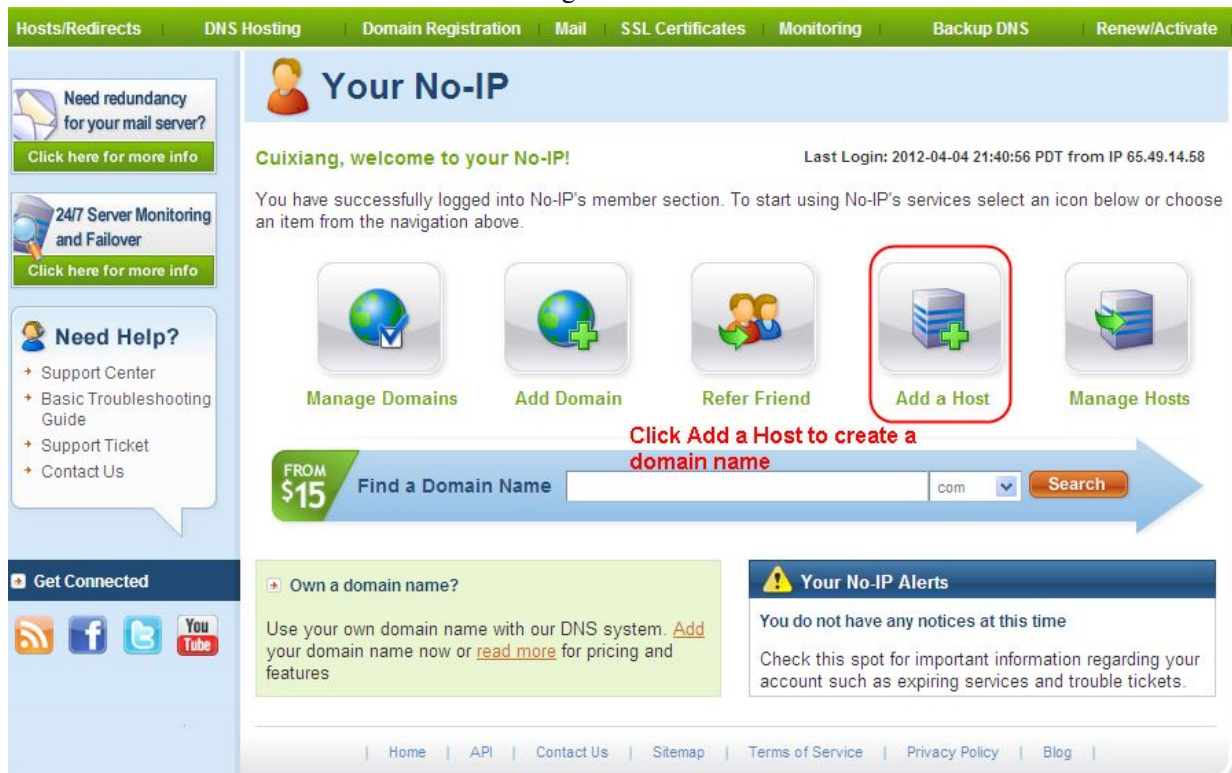

Figure 4.28

Please create the domain name step by step according to instructions on www.no-ip.com

Step 2 DO DDNS Service Settings within the Camera

Please set DDNS Settings within the camera by hostname, a user name and password you've got from www.no-ip.com

Take hostname ycxgwp.no-ip.info, user name **foscam**, password **foscam2012** for example.

Firstly, goes to option of DDNS Settings on the administrator panel.

Secondly, select No-IP as a server.

Thirdly, fill foscam as DDNS user, fill password foscam2012 as DDNS password, fill ycxgwp.no-ip.info as DDNS domain and server URL, Then click save to make effect. The camera will restart and to take the DDNS settings effective.

Fourthly, after the restart, login the camera, and go to option of Device Status on the administrator panel, and check if the DDNS status is successful.

If failed, please double check if you have input the correct hostname, user name, and password, and try to redo the settings.

NOTE :

If you have set Third Party DDNS successfully ,the Foscam Domain Name will be invalid. The Third Party DDNS and the Foscam Domain Name cannot work at the same time, the last time you configured will take effect.

② Do port forwarding within the router

Example: The camera's LAN IP address is <http://192.168.8.100:2000>

Firstly, login the router, goes to the menu of Port Forwarding or Port Trigger (or named Virtue Server on some brands of router). Take Linksys brand router as an example, Login the router, and goes to Applications & Gaming->Single Port Forwarding.

Secondly, Create a new column by LAN IP address & HTTP Port No. of the camera within the router showed as below.

Application Name	External Port	Internal Port	Protocol	To IP Address	Enabled
None	---	---	---	192.168.8.	<input type="checkbox"/>
None	---	---	---	192.168.8.	<input type="checkbox"/>
None	---	---	---	192.168.8.	<input type="checkbox"/>
None	---	---	---	192.168.8.	<input type="checkbox"/>
None	---	---	---	192.168.8.	<input type="checkbox"/>
Http	2000	2000	Both	192.168.8.100	<input checked="" type="checkbox"/>
Media	9200	9200	Both	192.168.8.100	<input checked="" type="checkbox"/>
				192.168.8.	<input type="checkbox"/>

Figure 4.29

③ Use domain name to access the camera via internet

After the port forwarding is finished, you can use the **domain name+ http no.** to access the camera via internet. Take hostname ycxgwp.no-ip.info and http no. 2000 for example, the accessing link of the camera via internet would be `http:// ycxgwp.no-ip.info:2000`

4.4.5 UPnP

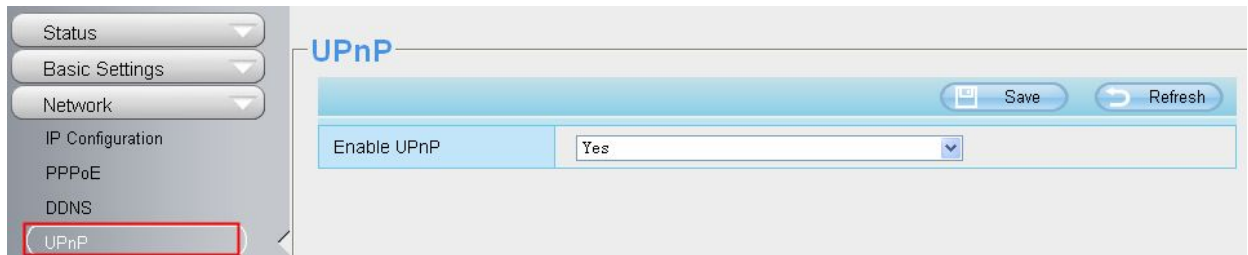

Figure 4.30

The default UPnP status is closed. You can enable UPnP, then the camera's software will be configured for port forwarding. Back to the "Device Status" panel, you can see the UPnP status:



Figure 4.31

The camera's software will be configured for port forwarding. There may be issues with your routers security settings, and sometimes may error. We recommend you configure port forwarding manually on your router .

4.4.6 Port

This camera supports HTTP Port / HTTPS Port/ ONVIF Port. HTTP Port is used to access the camera remotely.

HTTP port : By default, the HTTP is set to 88. Also, they can be assigned with another port number between 1 and 65535. But make sure they can not be conflict with other existing ports like 25, 21.

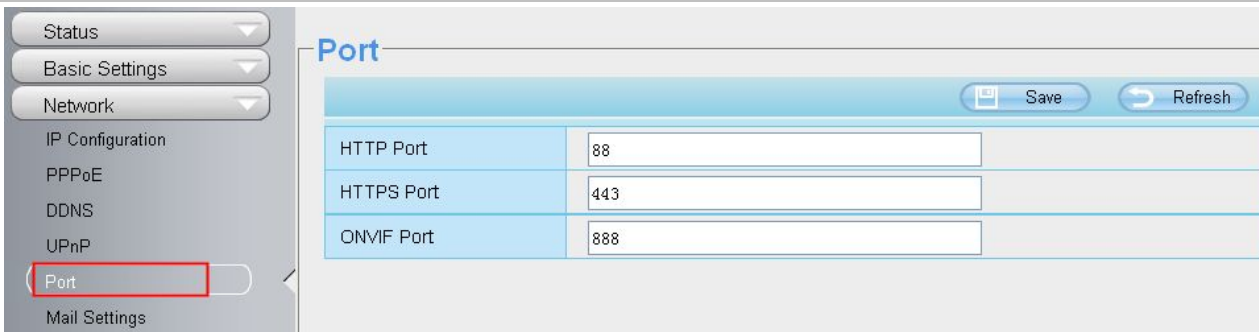

Figure 4.32

Another way to change the HTTP port no.

Step 1: Open the Equipment Search Tool, select the camera you would like to change the port of, right click on the IP address, and click on "Network Configuration", this brings up the network configuration box .

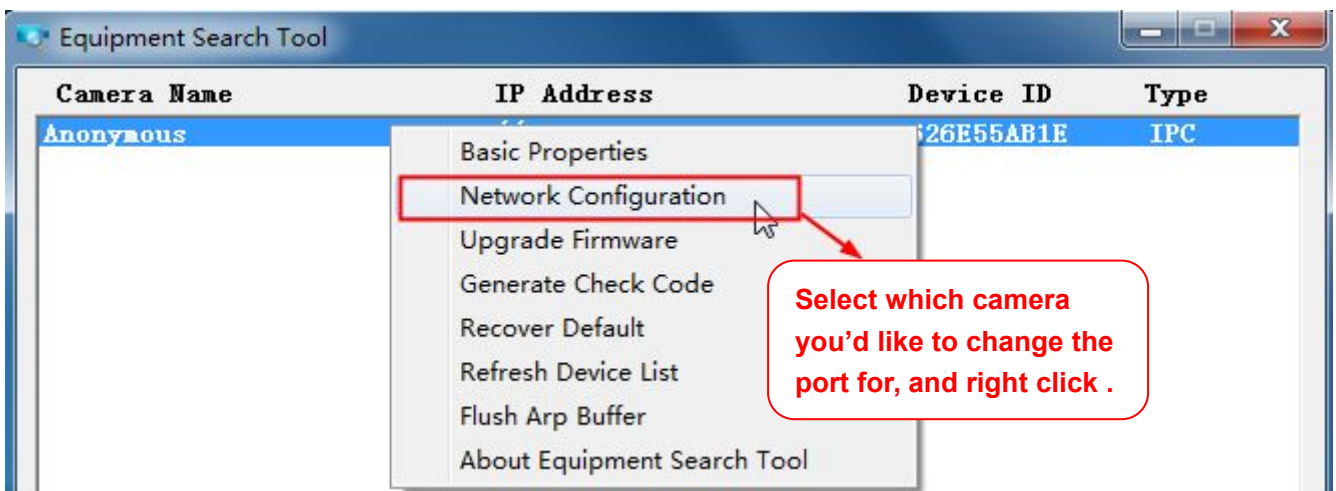

Figure 4.33

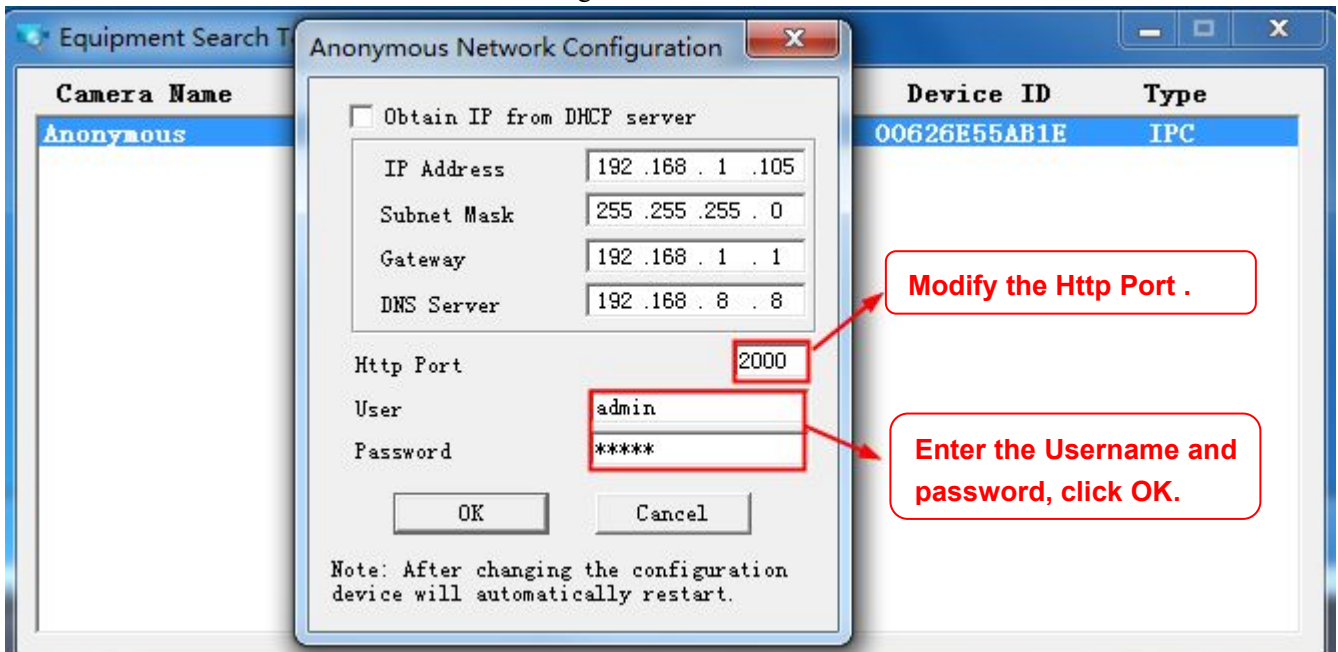
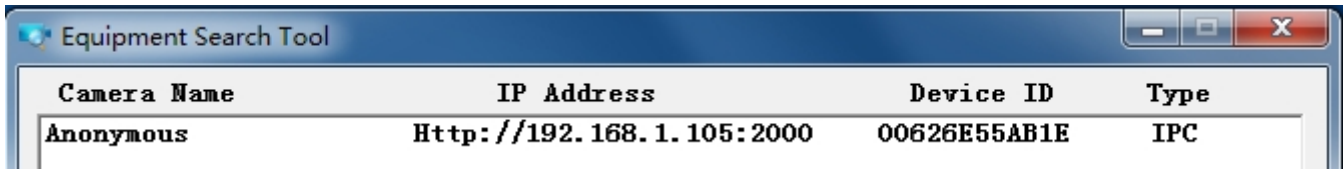

Figure 4.34

Step 2: Enter the username and password of the Administrator (default username is admin with a blank password), and click "OK" to apply changes.

Step 3: Wait around 10 seconds, you'll see that the camera's LAN IP address has changed. In our example it was changed to 2000, so we see `http://192.168.1.105:2000` in Equipment Search Tool. Also, the LAN IP address is now fixed at a static IP address of `http://192.168.1.105:2000`. This IP address will not change even if the camera is powered off and back on, the camera will remain on this LAN IP address. This is very important that a static LAN IP address is set, or you may have problems later with remote access and seeing the camera remotely if the camera loses power and reconnects on a different LAN IP address. Make sure you set a static LAN IP address!



Camera Name	IP Address	Device ID	Type
Anonymous	Http://192.168.1.105:2000	00626E55AB1E	IPC

Figure 4.35

NOTE: If the camera cannot be accessed, please make sure the port forwarding is succeed.

HTTPS port: The default port is 443. You can use the url to access the camera: `https:// IP + HTTPS port`.

ONVIF port: By default, the ONVIF port is set to 888. Also, they can be assigned with another port number between 1 and 65535(except 0 and 65534). But make sure they can not be conflict with other existing ports.

RTSP port:The default port is 554,only some IP Cameras have RTSP port.

4.4.7 Mail Settings

If you want the camera to send emails when motion has been detected, here Mail will need to be configured.

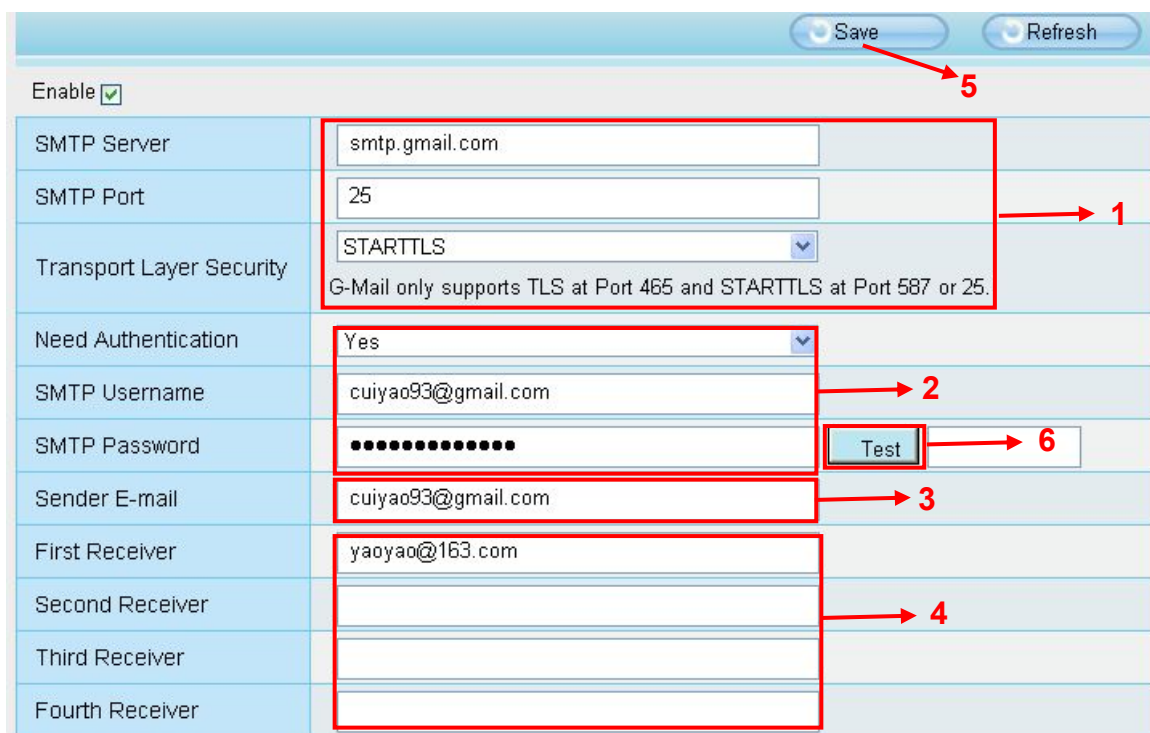

Save Refresh

Enable

SMTP Server	smtp.gmail.com	
SMTP Port	25	1
Transport Layer Security	STARTTLS	
G-Mail only supports TLS at Port 465 and STARTTLS at Port 587 or 25.		
Need Authentication	Yes	
SMTP Username	cuiyao93@gmail.com	2
SMTP Password	6
Sender E-mail	cuiyao93@gmail.com	3
First Receiver	yaoyao@163.com	
Second Receiver		4
Third Receiver		
Fourth Receiver		

Test

Figure 4.36

1----- SMTP Server/ Port /Transport Layer Security Enter SMTP server for sender. SMTP port is usually set as 25. Some SMTP servers have their own port, such as 587 or 465, and Transport Layer Security usually is None. If you use Gmail, Transport Layer Security must be set to TLS or STARTTLS and SMTP Port must be set to 465 or 25 or 587, which port you choose should be decided by which Transport Layer Security you select.

2-----SMTP Username/ password: ID account and password of the sender email address

3----- Sender E-mail Mailbox for sender must support SMTP

4----- Receiver Mailbox for receiver need not support SMTP, you can set 4 receivers

5----- Save Click Save to take effect

6----- Test Click Test to see if Mail has been successfully configured.

Click Test to see if Mail has been successfully configured.

The screenshot shows a web-based configuration form for SMTP settings. At the top right, there are 'Save' and 'Refresh' buttons. Below them is an 'Enable' checkbox which is checked. The form contains several input fields and dropdown menus:

- SMTP Server: smtp.gmail.com
- SMTP Port: 25
- Transport Layer Security: STARTTLS (dropdown menu)
- Need Authentication: No (dropdown menu)
- SMTP Username: yaoyao@gmail.com
- SMTP Password: masked with dots
- Sender E-mail: yaoyao@gmail.com
- First Receiver: yaoyao@163.com
- Second Receiver: (empty)
- Third Receiver: (empty)
- Fourth Receiver: (empty)

Next to the SMTP Password field is a 'Test' button. To its right, the word 'Success' is displayed in a green box, with a red arrow pointing to it from a red-bordered box containing the text 'Test result .'. The 'Save' and 'Refresh' buttons are at the top right of the form area.

Figure 4.37

If the test success, you can see the Success behind the Test, at the same time the receivers will receive a test mail.

If the test fails with one of the following errors after clicking Test, verify that the information you entered is correct and again select Test .

- 1) Cannot connect to the server
- 2) Network Error. Please try later
- 3) Server Error
- 4) Incorrect user or password
- 5) The sender is denied by the server. Maybe the server need to authenticate the user, please check it and try again
- 6) The receiver is denied by the server. Maybe because of the anti-spam privacy of the server
- 7) The message is denied by the server. Maybe because of the anti-spam privacy of the server
- 8) The server does not support the authentication mode used by the device

4.4.8 FTP Settings

If you want to upload record images to your FTP server, you can set **FTP Settings**.

The screenshot shows the FTP Settings configuration window. At the top right, there are 'Save' and 'Refresh' buttons. The configuration fields are as follows:

FTP Server	ftp://192.168.8.150 Example:ftp://192.168.1.103/dir The maximum length of the address is 127, does not support the character & =
Port	21
FTP Mode	PORT
Username	yaocuixiang The maximum length of the user name is 63, support numbers, letters and symbols _ @ \$ * - , . # !
Password	●●●●●●●● The maximum password length is 63, does not support the character & =
Test	Success

Figure 4.38

The screenshot shows the FTP Settings configuration window for an internet-based server. At the top right, there are 'Save' and 'Refresh' buttons. The configuration fields are as follows:

FTP Server	ftp://ftp.mgenseal.com Example:ftp://192.168.1.103/dir The maximum length of the address is 127, does not support the character & =
Port	21
FTP Mode	PORT
Username	deotestge The maximum length of the user name is 63, support numbers, letters and symbols _ @ \$ * - , . # !
Password	●●●●●●●● The maximum password length is 63, does not support the character & =
Test	Success

Figure 4.39

FTP server: If your FTP server is located on the LAN, you can set as Figure 4.38.

If you have an FTP server which you can access on the internet, you can set as Figure 4.39.

Port: Default is port 21. If changed, external FTP client program must change the server connection port accordingly.

FTP Mode: Here supports two modes: PORT and PASV.

Username/password: The FTP account and password.

Click Save to take effect.

Click Test to see if FTP has been successfully configured.

4.4.9 P2P (Except FI9804W/ FI9805W/ FI9805E)

Access the camera by smart phone (Android or iOS operating system), please refer to the Quick Installation Guide.

First of all, you need to open the P2P function of the camera at “Settings-->Network-->P2P.”

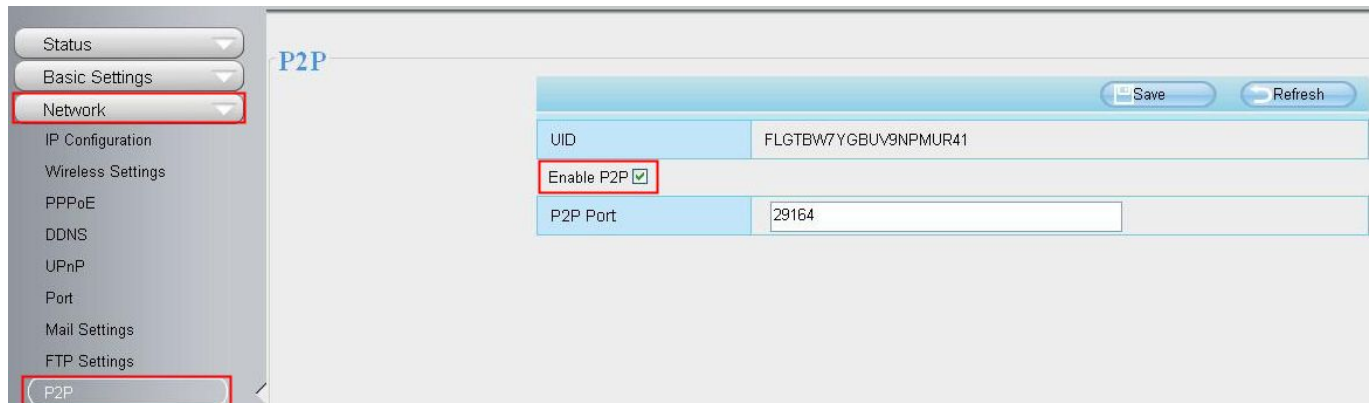

Figure 4.40

4.5 Video

This section allows you to configure Video stream settings, On screen display and Snapshot settings.

4.5.1 Video Settings

There are two ways to set the stream video settings. They are main stream video settings and sub stream video settings.

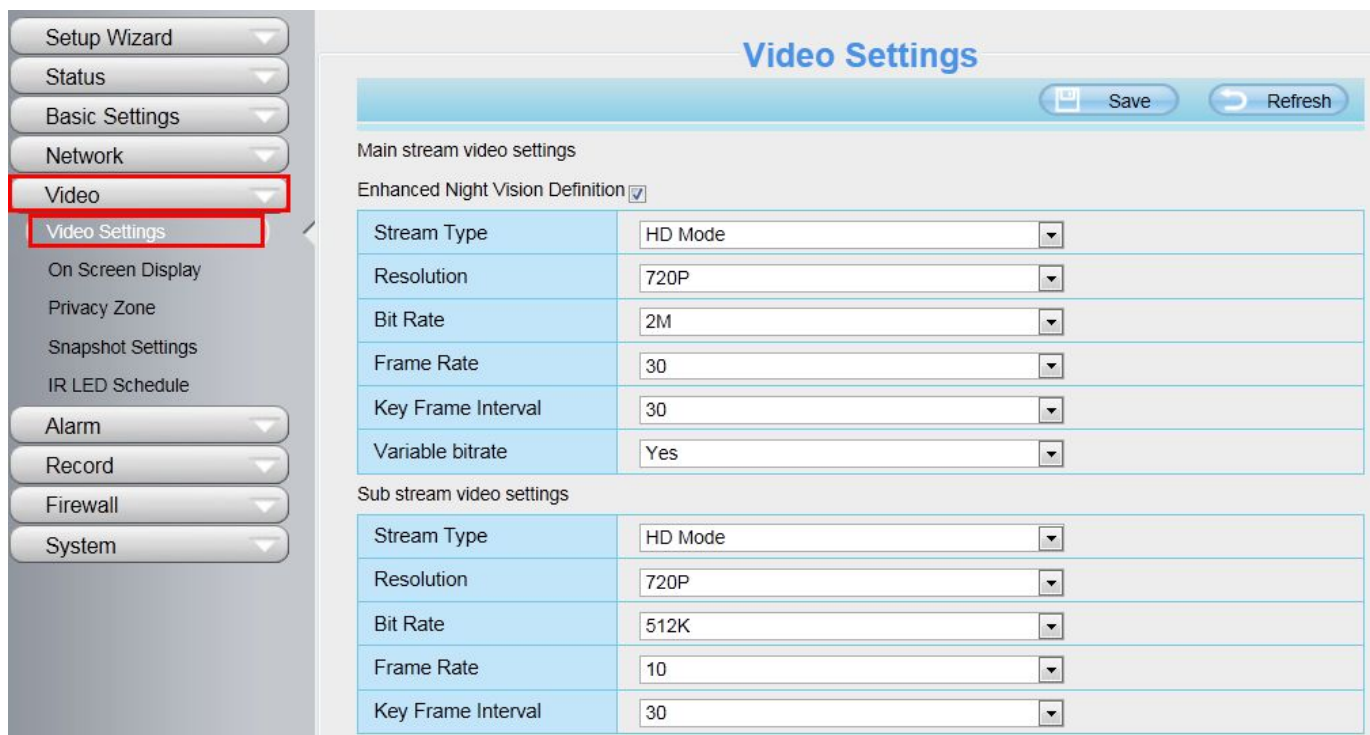

Figure 4.41

Enhanced Night video Definition: The camera will automatically drop the frame to extend the recording time in the night.

Stream Type: There are four types to identify different streams you have set. If select the HD Mode, the clearer video will become, and it will take up more bandwidth; If select the Smooth Mode, the bandwidth is very narrow, and bit rate is large, that will lead to video can not play well. The Equilibrium Model is a value between HD Mode and Smooth Mode.

Resolution: The camera supports multiple types, For example: 1080P, 960P, 720P, VGA. The higher the resolution is, the clearer video will become. But the code flux will become larger too, and it will take up more bandwidth. (Different models support different specific types.)

Bit Rate: Generally speaking, the larger the bit rate is, the clearer video will become. But the bit rate configuration should combine well with the network bandwidth. When the bandwidth is very narrow, and bit rate is large, that will lead to video can not play well.

Frame Rate: Note that a larger frame size takes up more bandwidth. You should lower frame rate when the bandwidth is limited. Normally, when the frame rate above 15, you can achieve fluently video. The maximum frame rate for each model is different, please see the “**Specifications**” .

Key Frame Interval: The time between last key frame and next key frame. The shorter the duration, the more likely you will get a better video quality, but at the cost of higher network bandwidth consumption.

Variable bitrate(except for FI9900P,FI9900EP): Select the Bit rate type to constant or variable. If select Yes, the camera will change the video bit rate according to the situation, but will not more than the maximum parameter "Bit Rate"; If select No, the Bit Rate is unchanged.

Rate Control Mode(FI9900P,FI9900EP, FI9901EP):There are three rate control modes.

CBR: Constant Bit Rate, it means that the Bit Rate is constant.

VBR: Variable Bit Rate, the camera will change the video bit rate according to the situation, but will not more than the maximum parameter "Bit Rate".

LBR: Low Bit Rate. If you can select the LBR, then you can slide the scroll bar to choose percentage of the bit rate. By reducing the bit rate, so that the camera can obtain a better image at low bandwidth.

4.5.2 On Screen Display

This page is used to add timestamp and device name on the video.

OSD	
Display Timestamp	Yes
Display Camera Name	Yes

Figure 4.42

Display Timestamp: There are two options: Yes or NO. Select Yes and you can see the system date on the video.

Display Camera Name: There are two options: Yes or NO. Select Yes and you can see the device name on the video.

4.5.3 Privacy Zone

Some models do not support this Function.

This page is used to add privacy zone on the video.

Privacy Zone	
Allow Privacy Zone	Yes

Set Privacy Zone

Figure 4.43

Allow On Screen Display Mask

There are two options: Yes or NO. Select yes and draw a mask area on the video, the mask area will be black on the video.



Figure 4.44

Click **OK** button and return to the **Privacy Zone** page, click Save to take effect.

Back to the surveillance window, you can see the privacy area as the following picture:



Figure 4.45

4.5.4 Snapshot Settings

On this page you can set the snapshot pictures' image quality and the storage path.

Snapshot Settings

Manual snap Quality	Medium
Pictures Save To	FTP

Enable timing to capture

Capture interval	2 (1-65535s)
------------------	--------------

Enable set Filename

Filename	NAME
----------	------

🕒 Schedule

All	00	01	02	03	04	05	06	07	08	09	10	11	12	13	14	15	16	17	18	19	20	21	22	23
MON																								
TUE																								
WED																								
THU																								
FRI																								
SAT																								
SUN																								

Figure 4.46

Manual snap Quality: Low, Middle and High. The higher the quality, the picture will be clearer.

Pictures Save To: FTP or SD card. If you have done FTP and Alarm settings, when alarming, the camera will snap pictures to the FTP or SD card automatically.

If you select the FTP, you can set the file name which the picture save to. For example: file name is "NAME", the snapshot picture is "NAME_20150605-180000.jpg".

Only FI9803EP, FI9900P, FI9900EP support SD card.

Enable timing to capture

To enable capture interval, follow the steps below:

1 Select Enable timing to capture

2 Capture interval: The interval time between two captures.

3 Select the capture time

● Capture anytime

Click the black button up the MON, you will see all time range turn red. When something moving in the detection area at anytime, the camera will capture.

● Specify an capture schedule

Click the week day words, the corresponding column will be selected. For example, click TUE, the all column of TUE turns to red, that means during Tuesday whole day, the camera will capture.

● Press the left mouse and drag it on the time boxes, you can select the serial area,

4 Click Save button to take effect.

4.5.5 IR LED Schedule

On this page you can set the schedule time for switching IR LED lights. When parameter Mode is set to the **Schedule** on the Live **Video** window, At these schedule time, the IR LED lights will be turned off.

Figure 4.47

4.6 Detector

4.6.1 Motion Detection

IP Camera supports **Motion Detection Alarm**, when the motion has been detected, it will send emails or upload images to FTP.

Figure 4.48

To enable motion detection, follow the steps below:

1 Enable Motion detection

2 Sensitivity---- It supports three modes: Low, Middle and High. The higher the sensitivity, the camera will be more easily alarmed. Select one motion sensitivity.

3 Trigger interval--- The interval time between two motion detections. Here supports 5s/6s/7s/8s/9s/10s/11s/12s/13s/14s/15s. Select one interval time.

4 There are some alarm indicators:

A Camera Sound and PC Sound

If the camera has connected with a speaker or other audio output device, if you select Camera Sound or PC Sound, when the motion has been detected, the people around the camera will hear beep alarm sound.

B Send E-mail

If you want to receive alarm emails when motion is detected, you must select Send E-mail and set Mail Settings first.

C Take Snapshot

If you select this checkbox, when the motion has been detected, the camera will snap the live view window as a still picture and load it to the FTP. Make sure you have set FTP and set FTP as the storage path in Video->Snapshot settings panel.

Time interval: The interval time between two pictures.

D Recording

If you select this checkbox, when the motion has been detected, the camera will recording and load it to the FTP server. Make sure you have set FTP and set FTP as the storage path in Video->Snapshot settings panel.

E Push message to the phone

If you select this checkbox, when the motion has been detected, the camera will push the message to the phone which has been connected the camera.

5 Set detect area

Click set detect area and it pop up a window, then you can draw the detection area. Click Back button after settings. When something moving in the detection area, the camera will alarm.

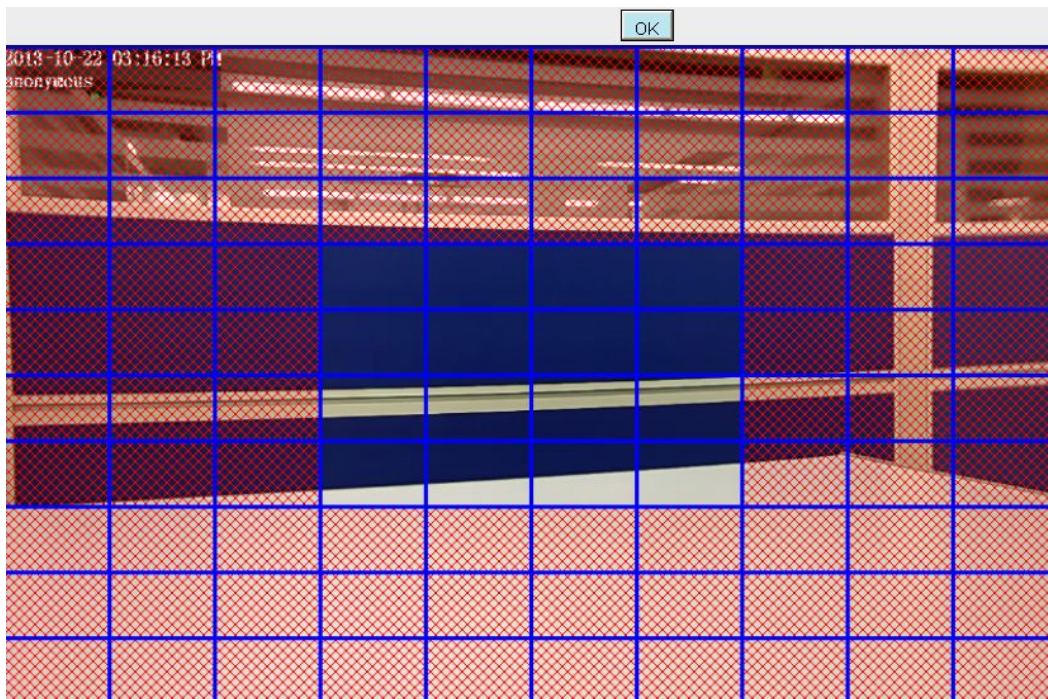

Figure 4.49

6 Alarm Schedule

① Alarm anytime when motion is detected

Click the black button up the MON, you will see all time range turn red. When something moving in the detection area at anytime, the camera will alarm.



Figure 4.50

② Specify an alarm schedule

Click the week day words, the corresponding column will be selected. For example, click TUE, the all column of TUE turns to red, that means during Tuesday whole day, when something moving in the detection area, the camera will alarm.

		Schedule																							
All	00	01	02	03	04	05	06	07	08	09	10	11	12	13	14	15	16	17	18	19	20	21	22	23	
MON																									
TUE																									
WED																									
THU																									
FRI																									
SAT																									
SUN																									

Figure 4.51

③ Press the left mouse and drag it on the time boxes, you can select the serial area,

		Schedule																							
All	00	01	02	03	04	05	06	07	08	09	10	11	12	13	14	15	16	17	18	19	20	21	22	23	
MON																									
TUE																									
WED																									
THU																									
FRI																									
SAT																									
SUN																									

When the PC sound alarm is enabled, the PC will make a sound only in Live Video page while the IPC detected an alarm

Figure 4.52

7 Click Save button to take effect. When the motion is detected during the detection time in the detection area, the camera will alarm and adopt the corresponding alarm indicators.

NOTE: You must set the detection area and detection schedule, or else there is no alarm anywhere and anytime.

4.6.2 Sound Detection

Some models support Sound alarm.

When the ambient sound over a certain decibel ,the sound alarm will be triggered.

Sound Detection

Enable

Sensitivity	Low
Triggered Interval	15s
Action	<input type="checkbox"/> Camera Sound <input type="checkbox"/> PC Sound
	<input checked="" type="checkbox"/> Send E-mail
	<input checked="" type="checkbox"/> Take Snapshot <input type="checkbox"/> Time Interval <input type="text" value="2s"/>
	Please set the capture storage location in advance.(Video -> Snapshot Settings)
	<input checked="" type="checkbox"/> Recording Please set the video storage location in advance.(Record -> Storage Location)
	<input checked="" type="checkbox"/> Push message to the phone

Schedule

All	00	01	02	03	04	05	06	07	08	09	10	11	12	13	14	15	16	17	18	19	20	21	22	23
MON																								
TUE																								

Figure 4.53

If the Sensitivity is set to “High”, the camera will detect the sound whose more than 55db.
 If the Sensitivity is set to “Medium”, the camera will detect the sound whose more than 65db.
 If the Sensitivity is set to “Low”, the camera will detect the sound whose more than 75db.
 If the Sensitivity is set to “Lower”, the camera will detect the sound whose more than 85db.
 If the Sensitivity is set to “Lowest”, the camera will detect the sound whose more than 95db.

4.6.3 IO Alarm(only FI9805E)

This IP camera provides a IO alarm terminal block which is used to connect to external input / output device. The alarm device(door sensor, infrared sensor, smoke detectors, etc) send input command to the network camera, then the network camera send output command to the alarm output device(local audible alarm, lights

IO

Save Refresh

Enable

Trigger level	Low	
Triggered Interval	5s	
Action	Camera Sound <input type="checkbox"/> PC Sound <input type="checkbox"/>	
	Send E-mail <input type="checkbox"/>	
	Take Snapshot <input type="checkbox"/> Time Interval 2s	
	Please set the capture storage location in advance. (Video -> Snapshot Settings)	
	Recording <input type="checkbox"/>	
	Please set the video storage location in advance. (Record -> Storage Location)	
IO Output <input type="checkbox"/>	Clear IO Alarm Output	

Schedule

All	00	01	02	03	04	05	06	07	08	09	10	11	12	13	14	15	16	17	18	19	20	21	22	23
MON																								
TUE																								

alarm,etc.

Figure 4.54

There is an IO alarm input/output lines in the FOSCAM camera tails. Enable IO alarm need this cable to connect to the alarm device (door sensor, infrared sensor, smoke detector, etc.).

I/O Alarm has four ports:

- Port 1 and port 2 indicate IO alarm input
- Port 3 and port 4 indicate IO alarm output



Figure 4.55

Setting IO alarm

On the IO page, Enable the I/O alarm, select the “**Send E-mail**”and “**Snapshot**” before you have configured the mail and FTP.

If an IO alarm is triggered and IO alarm output device will always alarm (sound alarm is issued a warning sound, alarm lights in flash etc.). Click "Clear IO alarm output" , the alarm output device will stop alarming. If IO alarm is triggered again after alarm interval, IO alarm output device will be restart.

Note: motion detection alarm can also be triggered IO alarm output.

4.7 Record

4.7.1 Storage Location

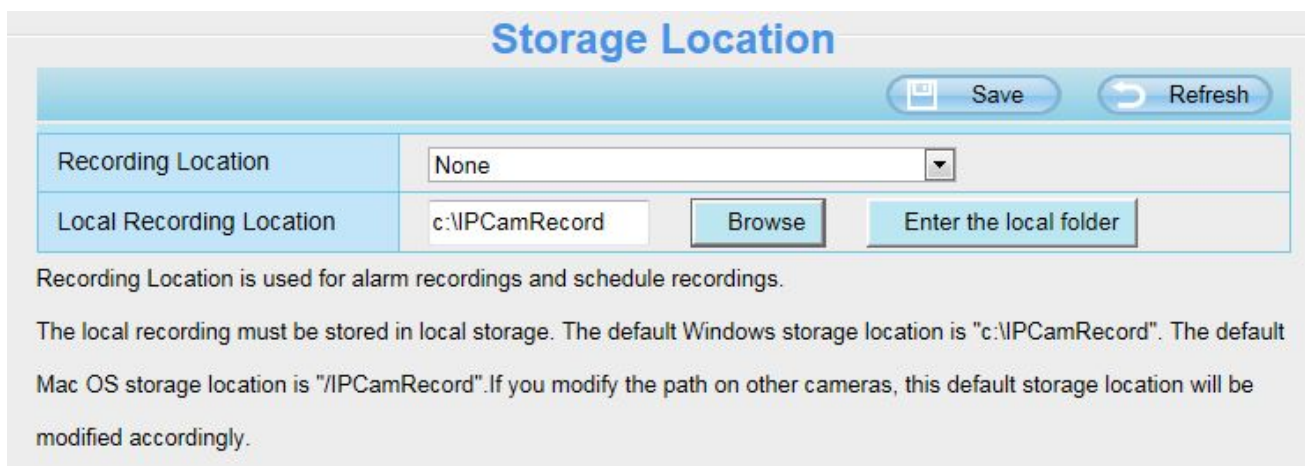

Figure 4.56

Recording Location : SD card, FTP.

- SD card(Only FI9803EP/FI9900P/FI9900EP/FI9901EP): The video will be saved in SD card. **Make sure the camera has been inserted the SD card.** On this page, you can see the available space of the SD card.
- FTP: The video will be saved in FTP. Please refer to "FTP settings."

Local Recording Location: For Windows OS, the manual recording path is C:/ IPCamRecord, you can change another one. For MAC OS, the manual recording path is: / IPCamRecord.

Enter the local folder :Click here,you can enter the local folder.

4.7.2 Alarm Record

Alarm Recording	
<input type="button" value="Save"/> <input type="button" value="Refresh"/>	
Enable Pre-Record <input checked="" type="checkbox"/>	
Pre-recorded Time	5s
Alarm Recording Time	30s

Figure 4.57

4.7.3 Local Alarm Location

On this page you can enable local alarm record, and select the local alarm record time.

Local Alarm Recording	
<input type="button" value="Save"/> <input type="button" value="Refresh"/>	
Enable Local Alarm Recording <input checked="" type="checkbox"/>	
Local Alarm Recording Time	30s

Figure 4.58

4.7.4 Schedule Recording

When the video is selected as FTP, the device supports scheduled recording.

Storage Location	
<input type="button" value="Save"/> <input type="button" value="Refresh"/>	
Recording Location	FTP
Local Recording Location	c:\PCamRecord <input type="button" value="Browse"/>

Figure 4.59

Scheduled Recording To FTP

Enable Scheduled Recording

Stream:

 Edit Scheduled Recording

All	00	01	02	03	04	05	06	07	08	09	10	11	12	13	14	15	16	17	18	19	20	21	22	23
MON																								
TUE																								
WED																								
THU																								
FRI																								
SAT																								
SUN																								

Figure 4.60

When the video is selected as SD card, the device supports pumping frame recording.(FI9803EP, FI9900P,FI9900EP support SD card).

Storage Location

Recording Location: 372.2 MB / 7.4 GB

Local Recording Location:

Figure 4.61

Scheduled Recording To SD Card

Enable Scheduled Recording

Enable Long-time recording	No
Record frame	30
Record full strategy	Cover
Audio Record	No
Stream	Main stream

All	00	01	02	03	04	05	06	07	08	09	10	11	12	13	14	15	16	17	18	19	20	21	22	23
MON																								
TUE																								
WED																								
THU																								
FRI																								

Figure 4.62

Record frame: There are six frame selections, such as 1/30, 4/30, 8/30, 15/30, 24/30, 30/30. Recommended default is 4/30. The greater the Frame rate is, the sharper picture quality is, and the greater of storage space is, the shorter the storage time is.

Record full strategy: When the SD card is full, you can choose to cover the previous recording, or stop recording.

Audio Record: You can choose "yes" or "no".

NOTES:

- Scheduled recording only supports video saved to the SD card or FTP server.
- The schedule recording will stop while alarm recording is beginning, and it will continue automatically after alarm recording end.
- You can refer to "alarm schedule." in "Alarm" about editing the time of recording Schedule.

4.7.5 SD Card Management(FI9803EP/FI9900P/FI9900EP/FI9901EP)

The SD card Slot inside the camera, if you want to install or remove the SD card, you need to open the camera.

When you plug in the SD card during the camera work process, please reboot the camera again, or else the SD Card may be cannot work well.

Go to the **Settings**→**Status**→**Device Status** page, you can see the SD card status.

The default storage path of alarm record files is SD card, when the available size of SD card is less than 256M, the old record files will be deleted automatically.

4.8 PTZ(only FI9805E)

This page will allow you to change the pan/tilt speed and do RS485 settings. (Only FI9805E have this feature)

4.8.1 Pan/Tilt Speed

There are five Pt speed types: very fast, fast, normal, slow and very slowly. Select the desired pan/tilt speed type and click save button .

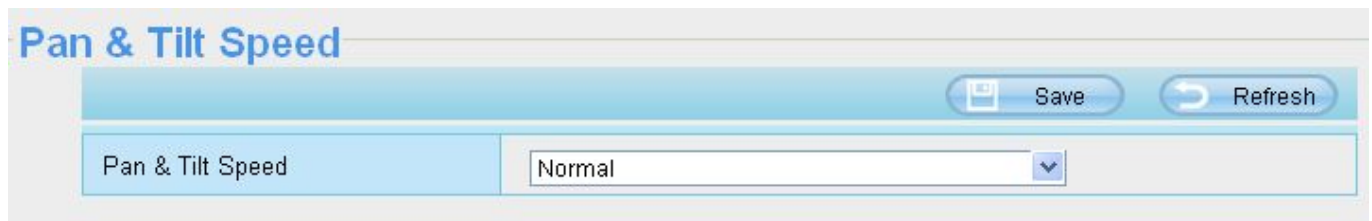
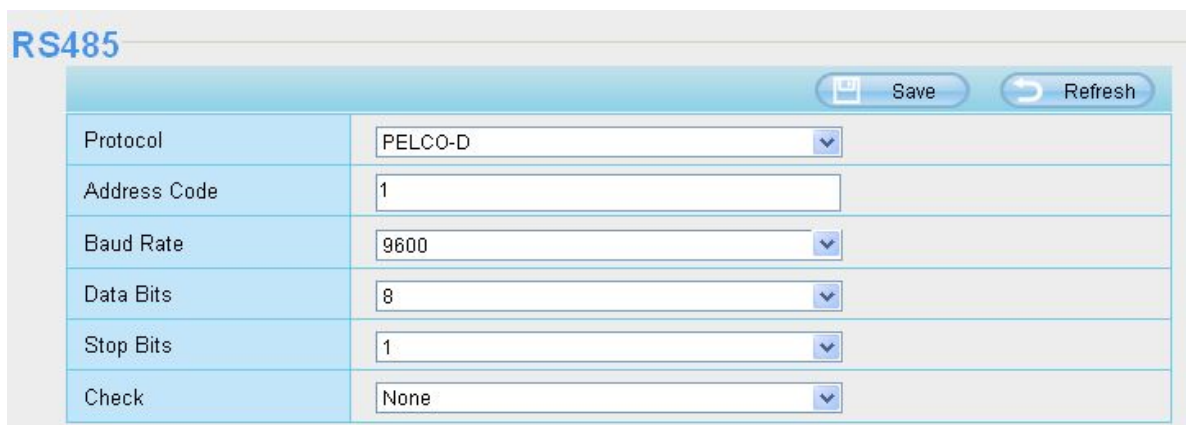

Figure 4.63

4.8.2 RS485 Configuration

This camera supports the standard 485 cradle head protocol (PELCO-D and PELCO-P). Please configure the RS485 protocol corresponding information first, or else the cradle head may cannot work.



RS485	
Protocol	PELCO-D
Address Code	1
Baud Rate	9600
Data Bits	8
Stop Bits	1
Check	None

Figure 4.64

4.9 Firewall

This section explains how to control the access permission by checking the client PC's IP addresses. It is composed of the following columns: **Block access from these IP addresses** and **Only allow access from these IP addresses**.

IP Filtering

Save Refresh

Enable Firewall

IP Filtering: Block access from these IP addresses

IP Address #1:

IP Address #2:

IP Address #3:

IP Address #4:

IP Address #5:

IP Address #6:

IP Address #7:

IP Address #8:

Figure 4.65

Enable firewall, If you select Only allow access from these IP addresses and fill in 8 IP addresses at most, only those clients whose IP addresses listed in the Only allow access from these IP addresses can access the Network Camera. If you select Block access from these IP addresses, only those clients whose IP addresses are in the IP list cannot access the Network Camera.

Click Save to take effect.

4.10 System

In this panel, you can back up/restore your camera settings, upgrade the firmware to the latest version, restore the camera to default settings and reboot the device.

4.10.1 Back-up& Restore

Click Backup to save all the parameters you have set. These parameters will be stored in a bin file for future use.

Click Browse and select the parameters file you have stored, then click Submit to restore the restore the parameters.

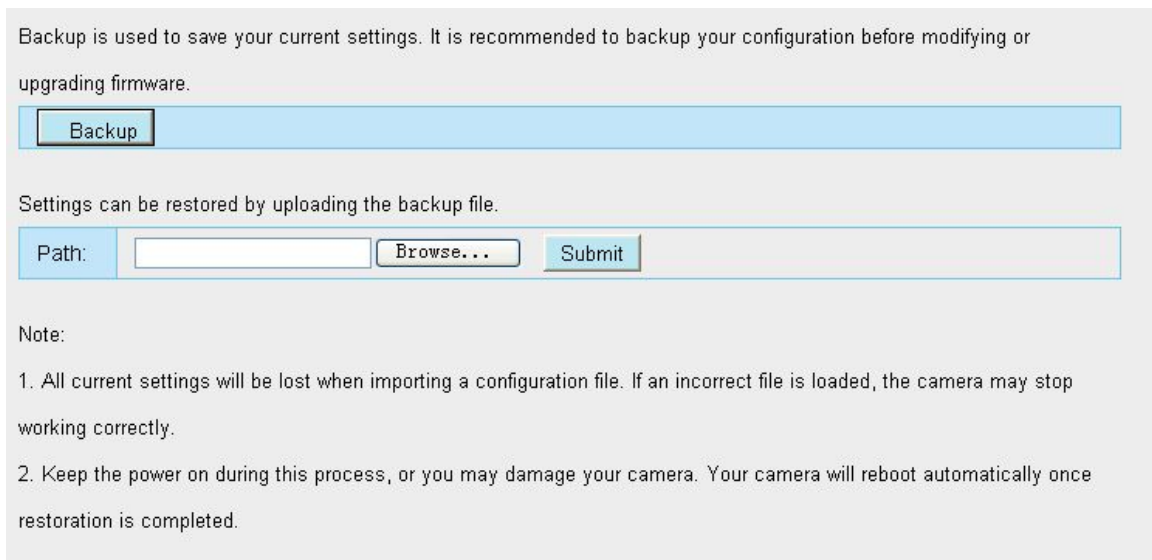

Figure 4.66

4.10.2 System Upgrade

Click “Download the latest firmware”, you will see the following screen. And click “save” to save the firmware on your computer locally.

Your current firmware version will be displayed on your screen. You may go to the **Status**→ **Device Information** page to check for the latest firmware versions available.

Click **Browse**, choose the correct bin file and then click **System upgrade**.

Don't shut down the power during upgrading. After upgrading, you can see the upgrade result.

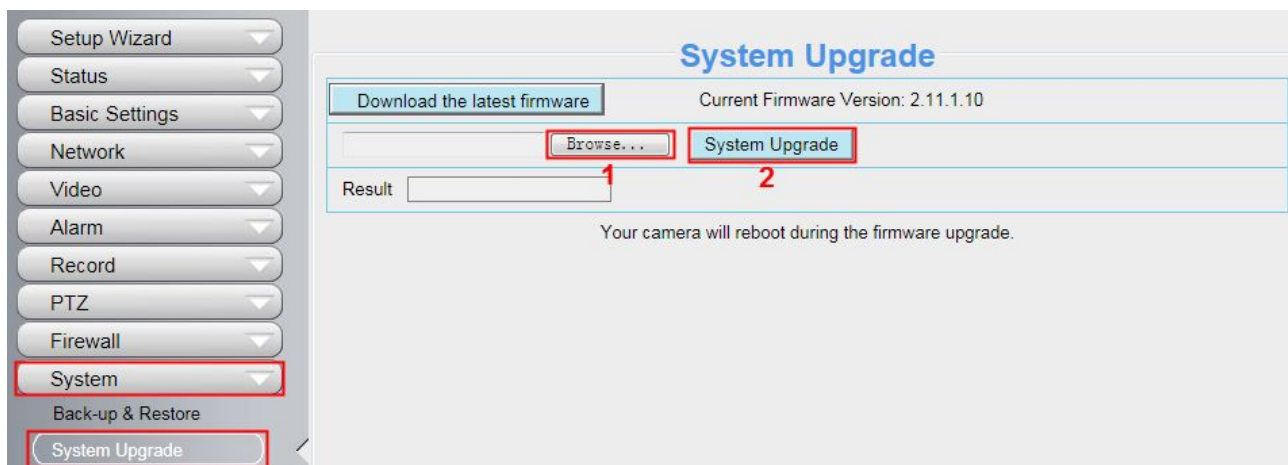



Figure 4.67

Upgrade Firmware by Equipment Search Tool

Double click the Equipment Search Tool shot icon , select the Camera IP that you want to upgrade the firmware. Then select Upgrade Firmware and enter the username and password, choose the firmware file, and upgrade.

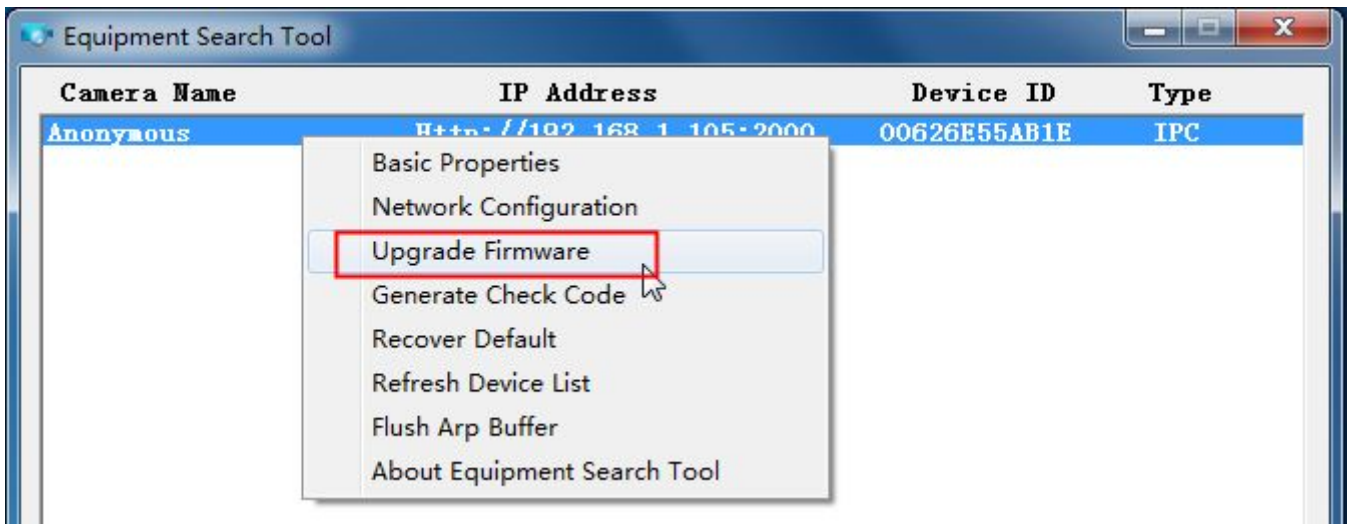

Figure 4.68

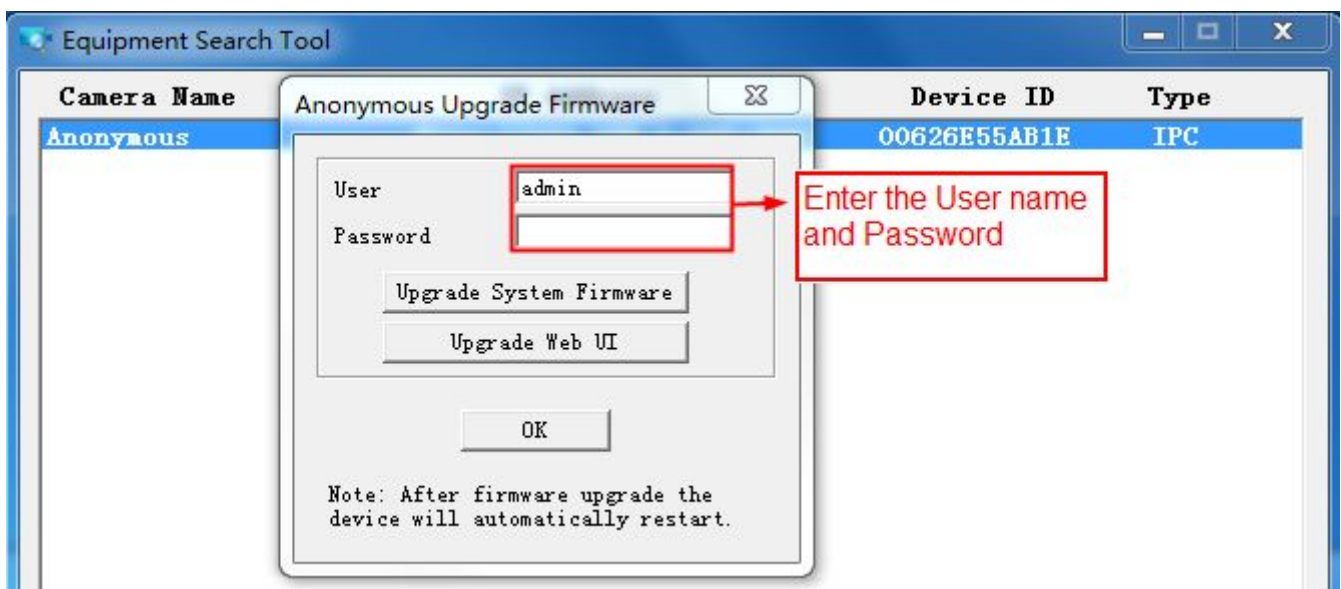

Figure 4.69

CAUTION:

If your camera works well with the current firmware, we recommend not upgrading. Please don't upgrade the firmware unnecessarily. Your camera may be damaged if mis-configured during an upgrade.

NOTE:

- 1) Don't upgrade the firmware through the web UI in WAN, or else the upgrade may be failed.
- 2) Please ensure you have download the correct firmware package for your camera before upgrading. Read the upgrade documentation (readme.txt file) in the upgrade package before you upgrade.
- 3) Upon downloading the firmware check the sizes of the .bin files. They must match the size in the readme.txt file. If not, please download the firmware again until the sizes are the same. Your camera will not function correctly if a corrupt .bin file is used.
- 4) Normally, only Device WEB UI need to be upgrade, please do not try to upgrade the Device Firmware.
- 5) Never shut down the power of the camera during upgrade until the IP camera restart and get connected.
- 6) After upgrade successfully, please clear the cache of browser, uninstall the old plugin and re-install it, then reset the camera to the default factory settings before using the camera.

4.10.3 Patch Installation

Click "Browse" to select the correct patch file, and then click "Install Patch" to install the patch. Do not turn off the power during it installing. After installing is complete, you will receive a system prompt.

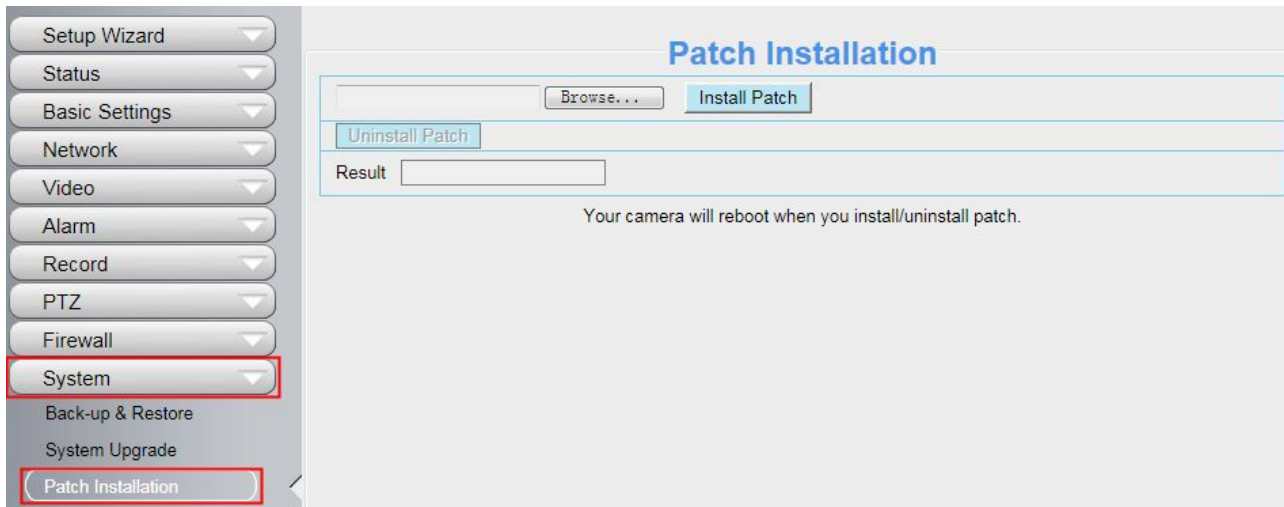

Figure 4.70

4.10.4 Factory Reset

Click **Factory Reset** button and all parameters will return to factory settings if selected. The default administrator username is admin with a blank password.

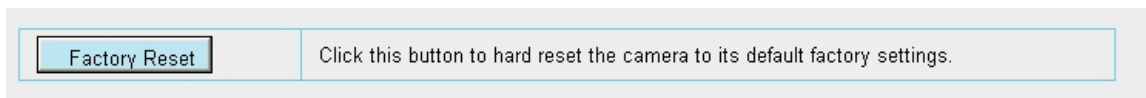

Figure 4.71

4.10.5 Reboot

Click **Reboot** to reboot the camera. This is similar to unplugging the power to the camera.

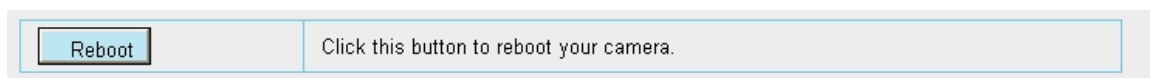
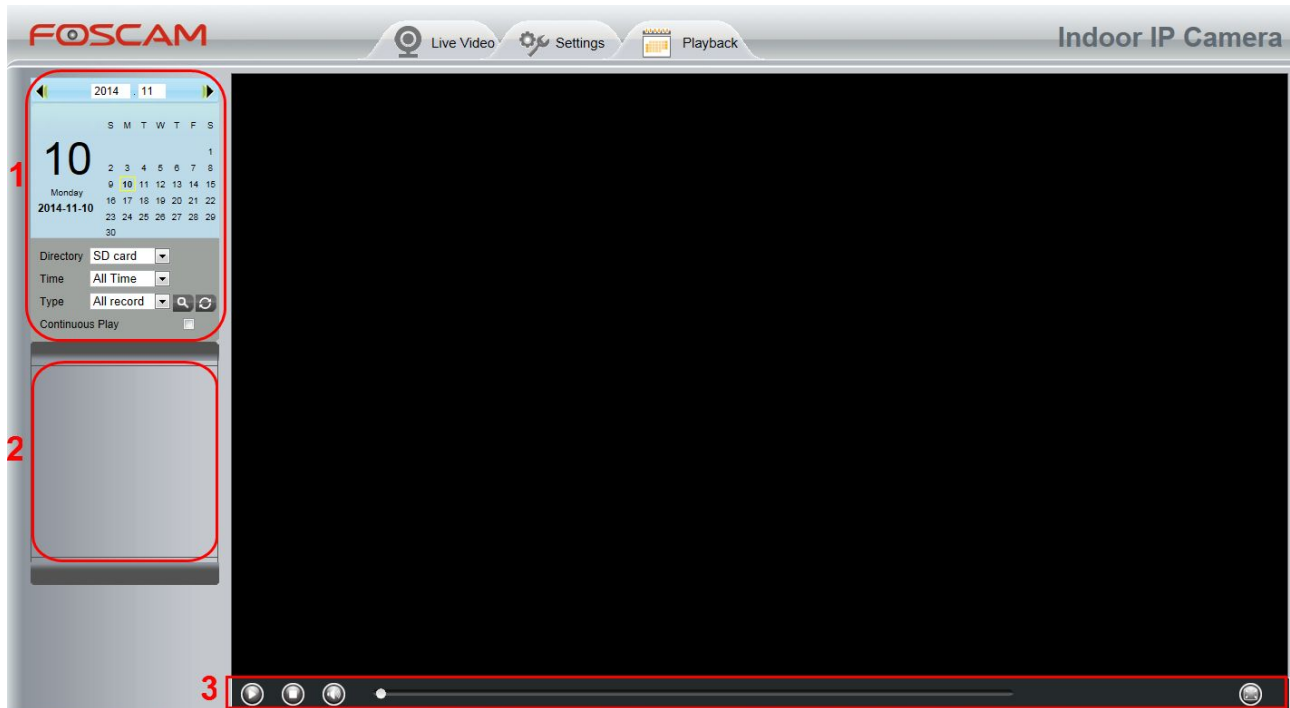

Figure 4.72

5 Playback(FI9803EP/FI9900P/FI9900EP)

On this page you can view the record files stored in the SD card.



Section 1 Define the Record files time and Type

Directory : The storage path of record files

Time : Here supports three types: current day, current month and All records. Another way, select the time on the time&date manually.



Type : The type of records files, Here supports two types: Normal record, Alarm record and All records.



: Click this button to search all record files satisfy the conditions you selected.

Continuous Play: Select the checkbox to play continuously all the record files.

Section 2 Search record files

On this panel you can see all record files satisfy the conditions you set.

Section 3 Play/Stop/Audio/Full screen buttons

Please select one record file before use these buttons.



Click this button to play the record files



Click this button to stop the record files



Open or stop audio



Click this button to make full screen, and double click left mouse to exit full screen.

6 Appendix

6.1 Frequently Asked Questions

6.1.1 Install the ActiveX of Firefox browser, Google Chrome and IE Chrome.

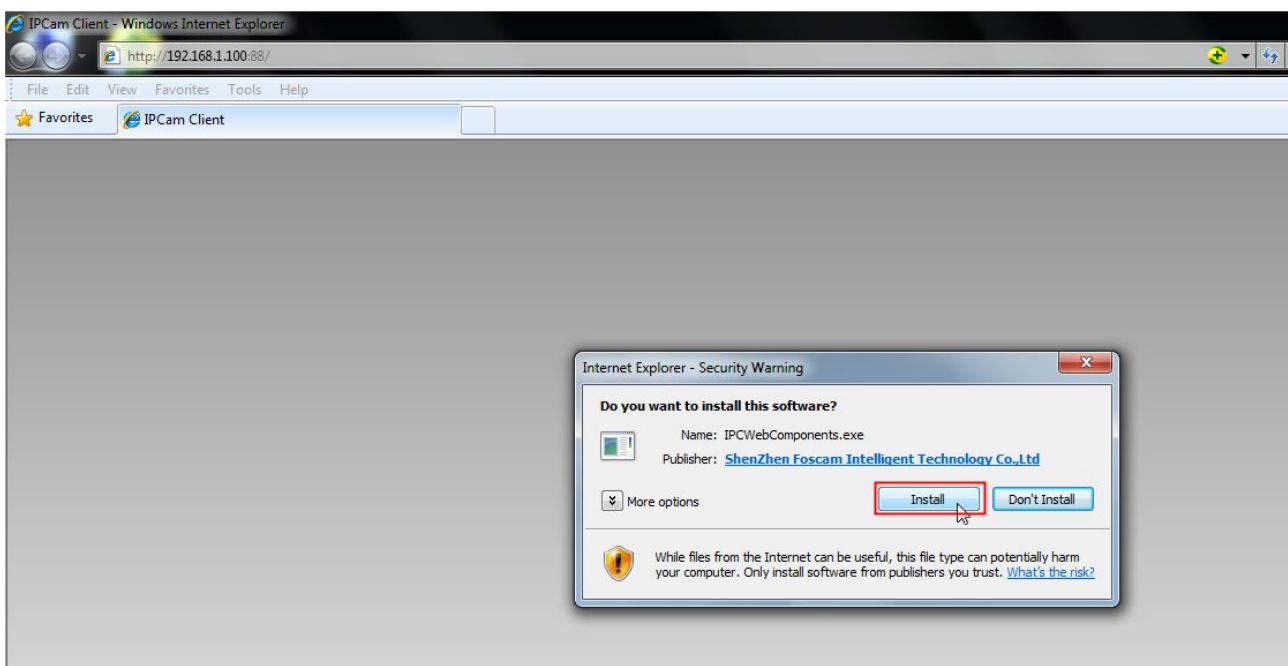

Figure 6.1

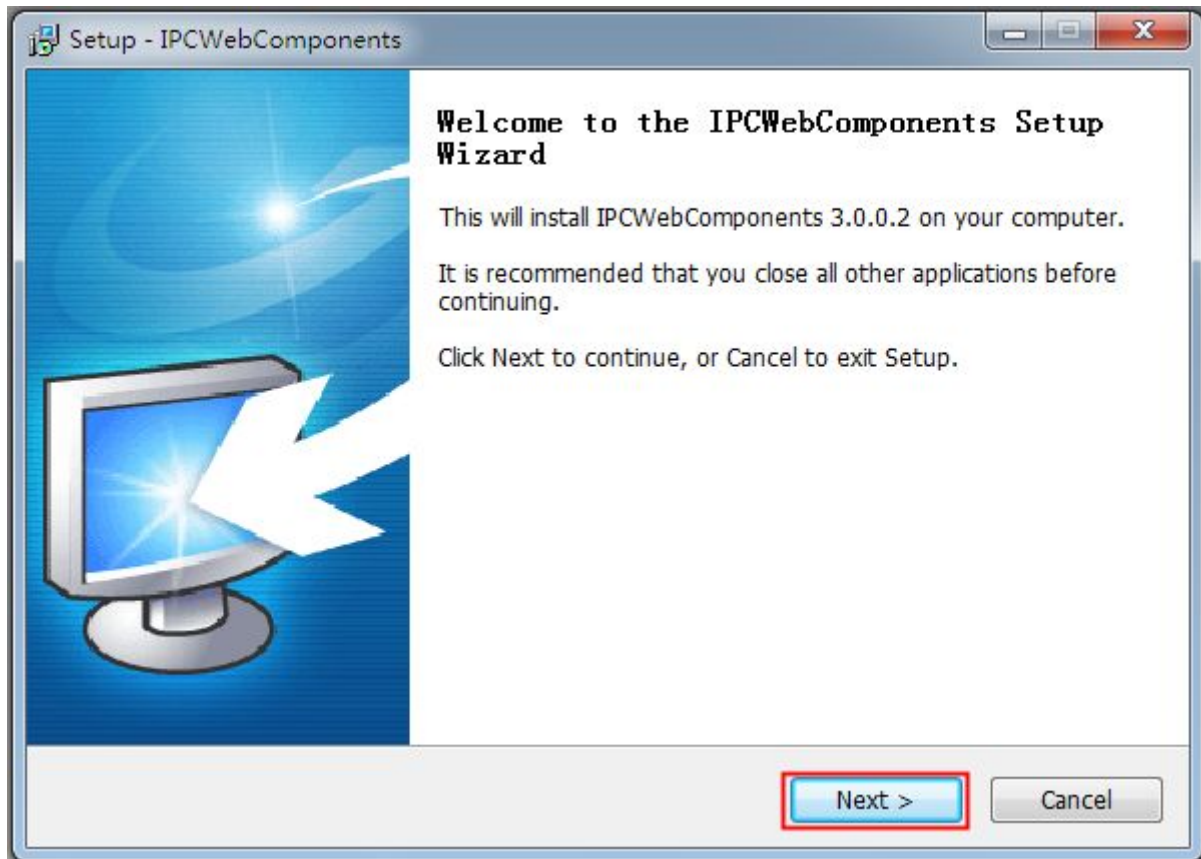

Figure 6.2

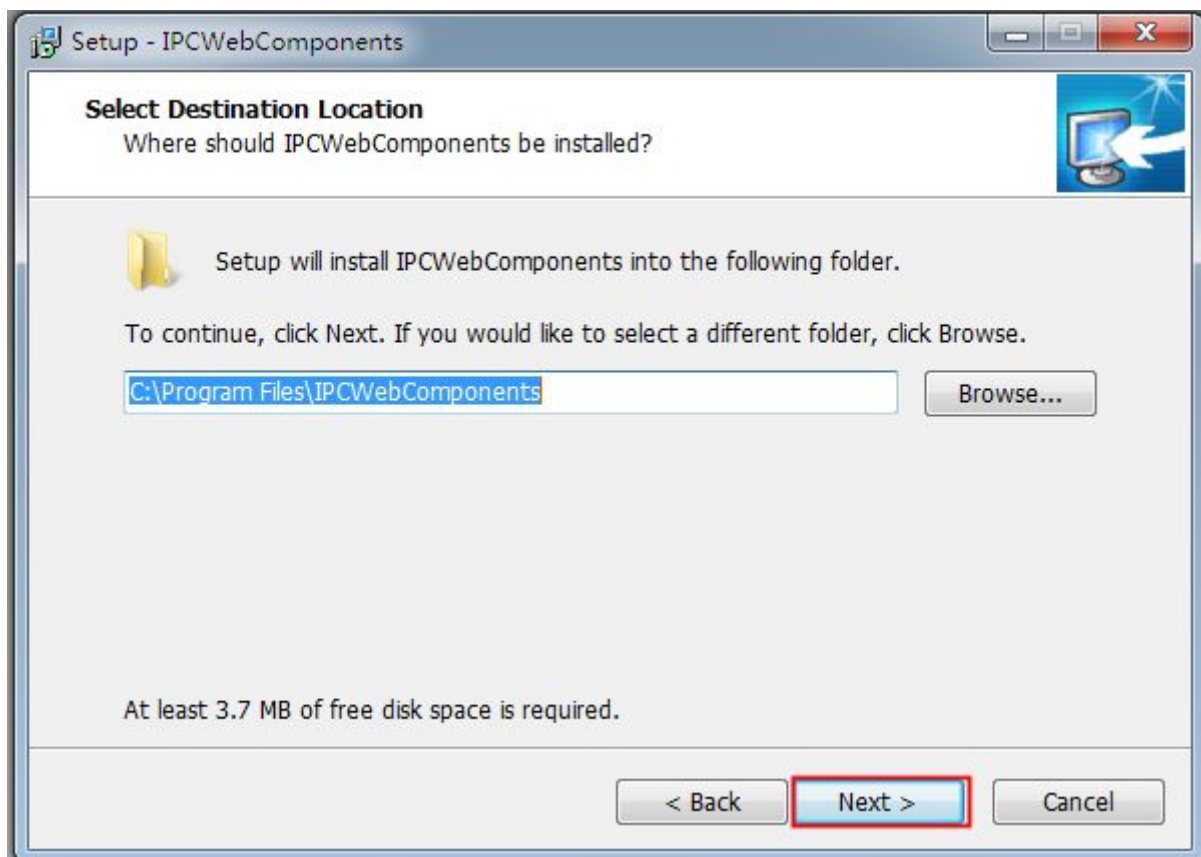

Figure 6.3

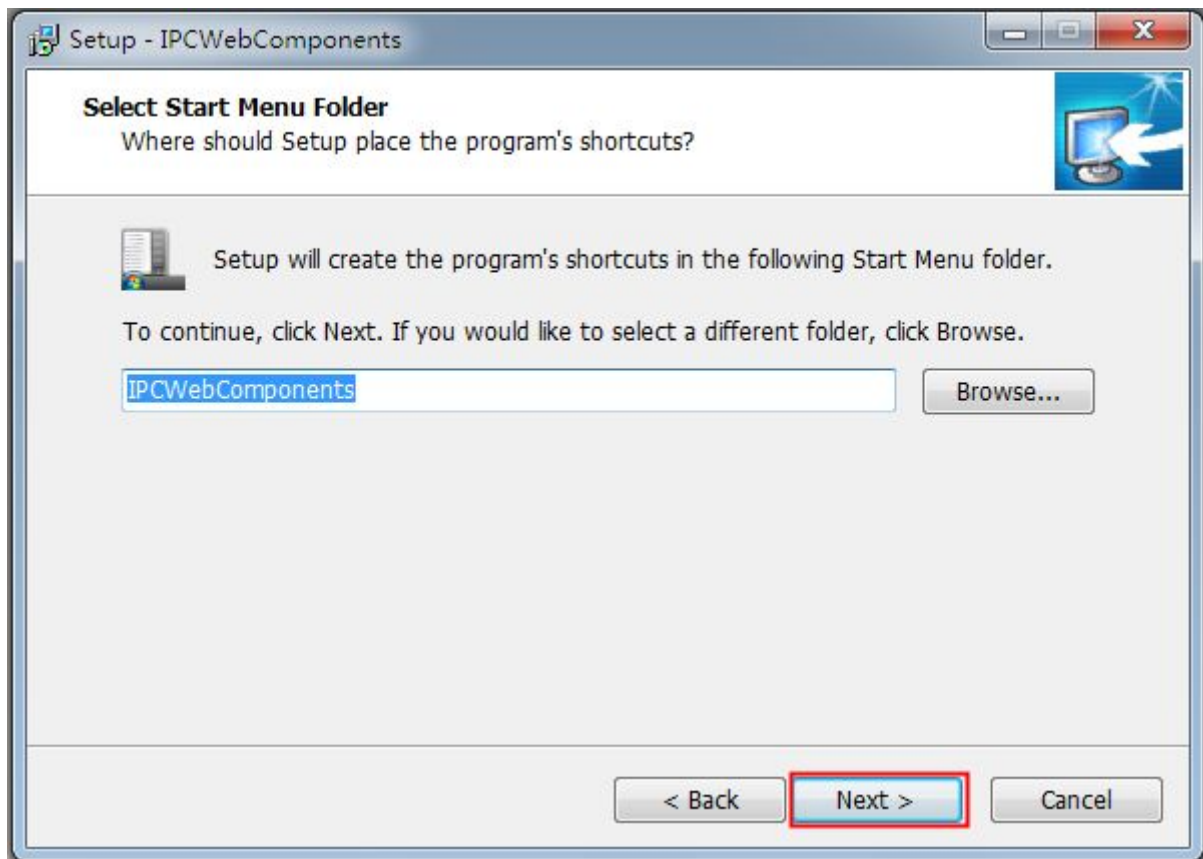

Figure 6.4

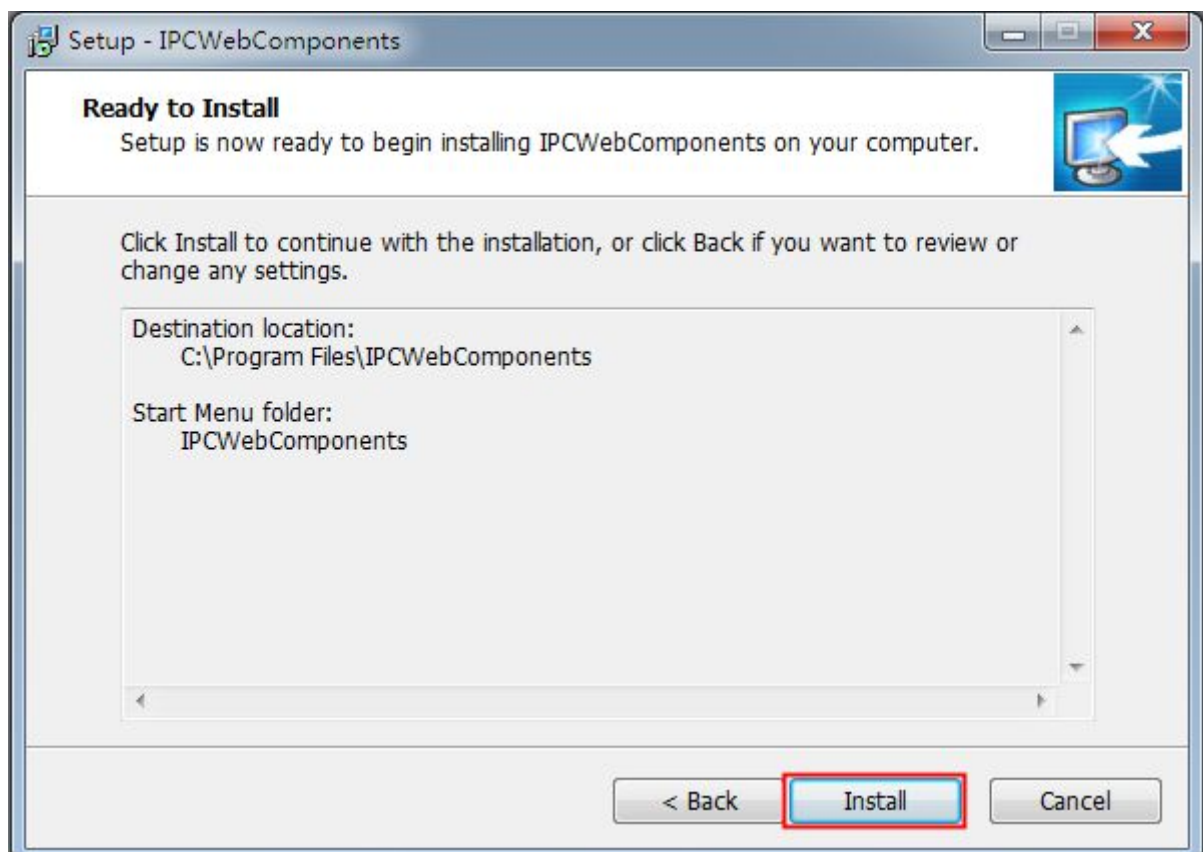

Figure 6.5

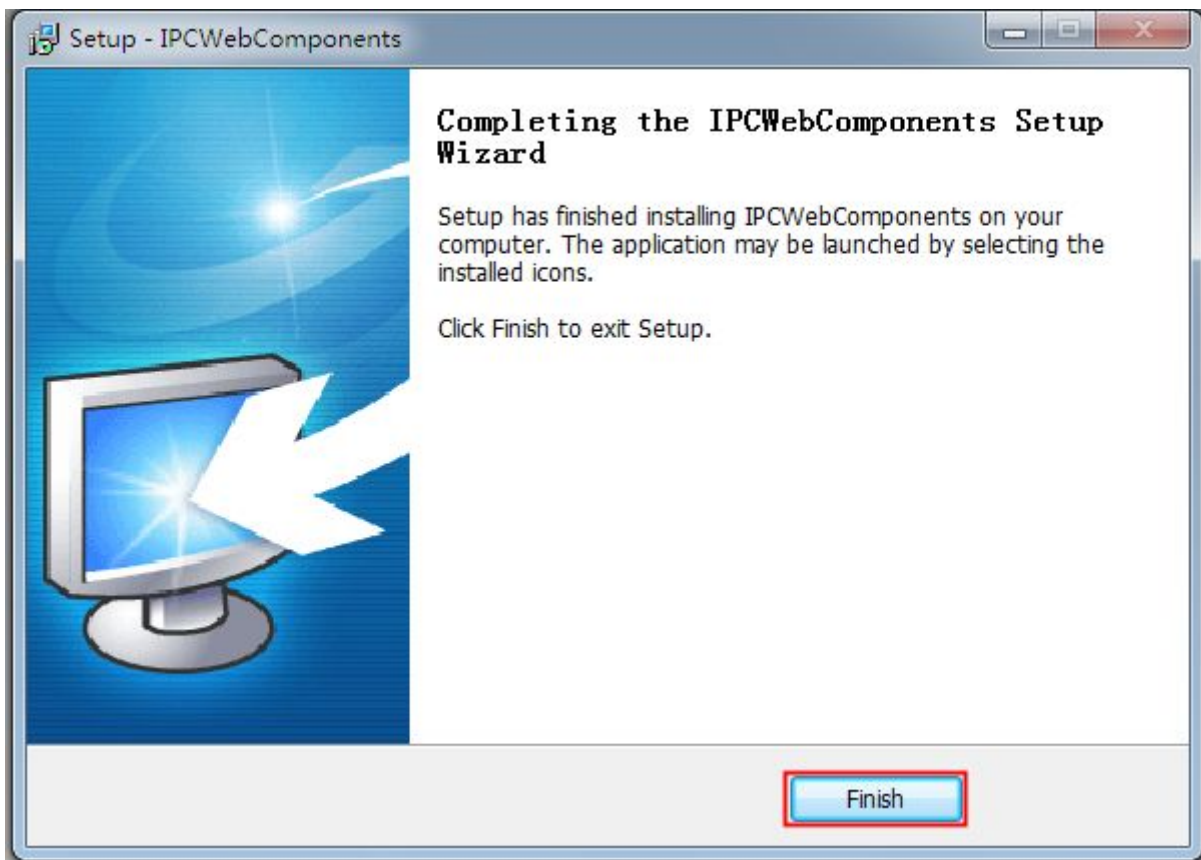

Figure 6.6

6.1.2 Uninstall the ActiveX of Firefox browser, Google Chrome and IE Chrome.

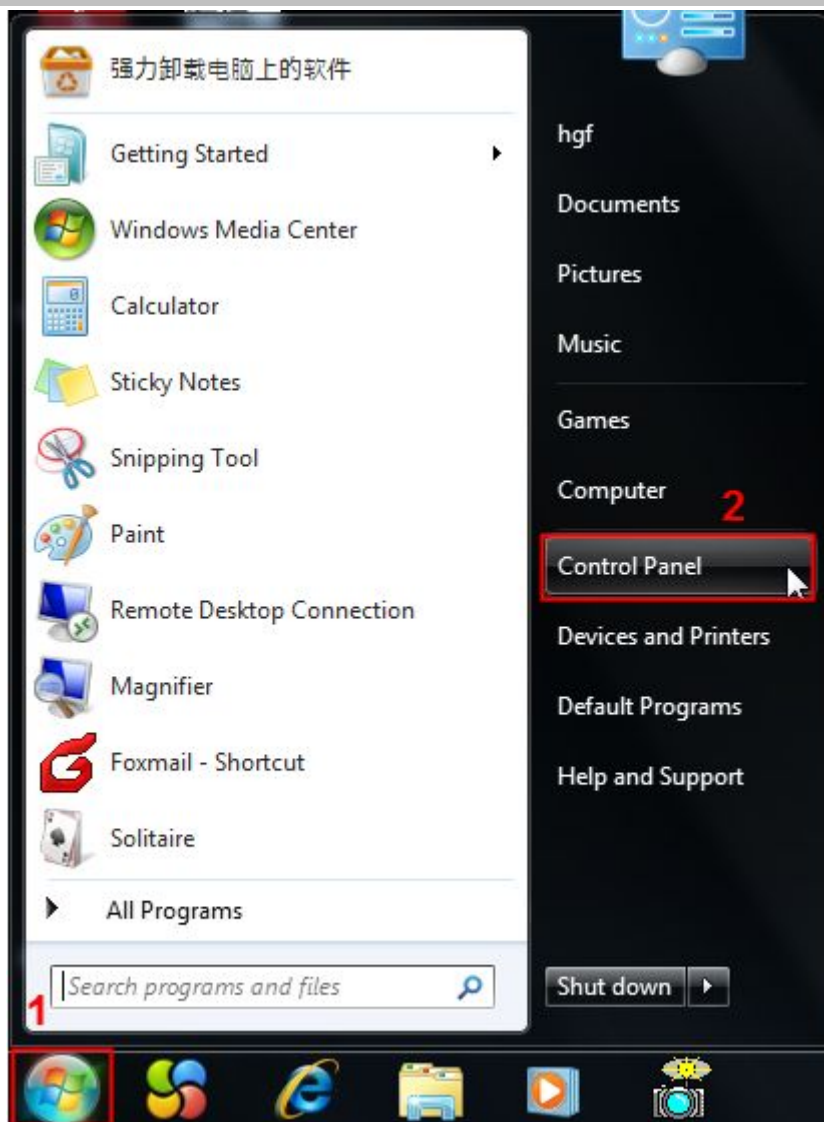

Figure 6.7

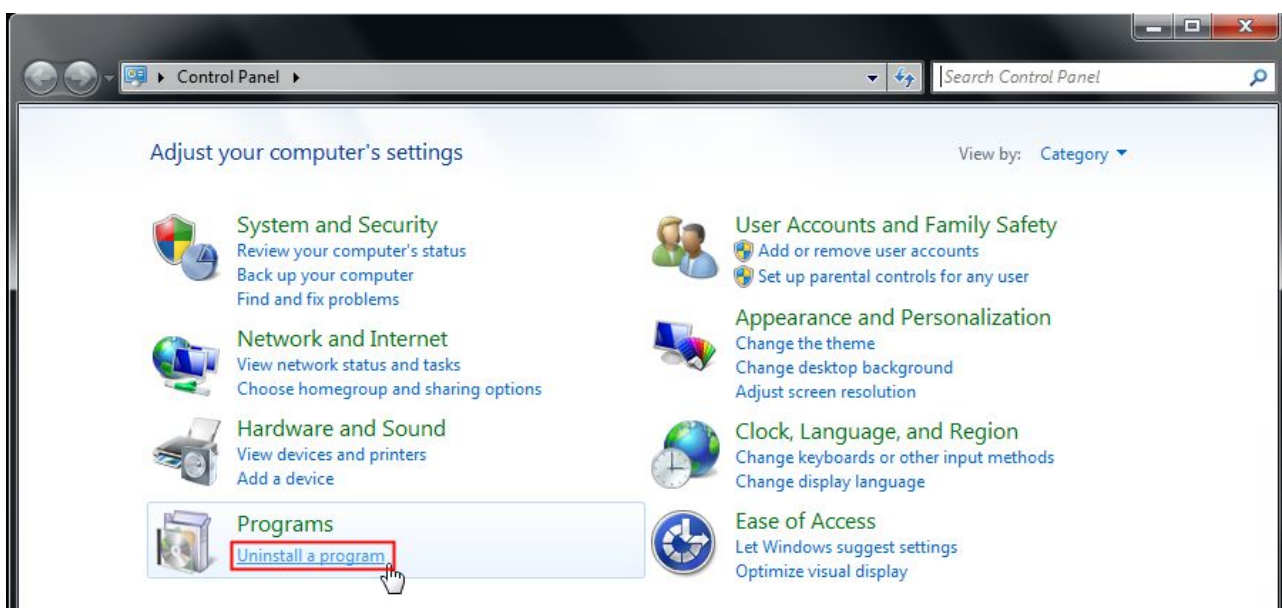

Figure 6.8

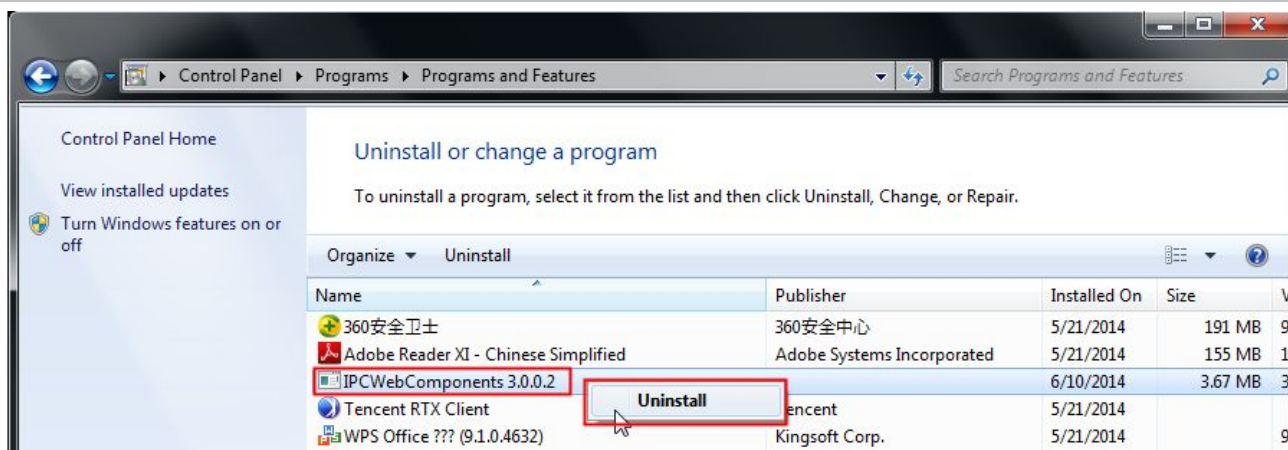

Figure 6.9

6.1.3 I have forgotten the administrator password

To reset the administrator password, you had better unplug the network cable firstly. After that, press and hold down the RESET BUTTON about 5 seconds. Releasing the reset button, the password will turn to the factory default.

Default administrator username/password: **admin with blank password**

6.1.4 Subnet doesn't match

Check whether your ip camera in the same subnet of your computer. The step is **Control Panel -- Network Connections -- Dbclick Local Area Connections -- Choose General -- Properties**.

Check subnet mask, IP address and gateways. When you set IP address please make sure they are in the same subnet. Otherwise you can't access camera.

6.1.5 Camera can not record

Camera can not record when I click Record button or I can't change the manually record path.

When you use Windows7 or Vista, you may be not able to do manually record or change the record path because of the security settings of computer.

There are two ways to resolve this problem:

- 1 Please add the camera as a trusted site to resolve this issue. The steps are IE browser--Tool--Internet Properties--Security--Trusted sites--Sites--Add
- 2 Open IE browser, then right click, select "Run as administrator"

6.1.6 No Pictures Problems

The video streaming is transmitted by the ActiveX controller. If ActiveX controller isn't installed correctly you will see no video image. You can resolve this problem by this way:

Download ActiveX controller and set the safety property of IE in the PC when you view it first time: IE

browser--Tool--Internet Proper--Security--Custom Level--ActiveX control and Plug-ins. Three options of front should be set to be “Enable”, The ActiveX programs read by the computer will be stored. As follows:

Enable: Download unsigned ActiveX controls

Enable: Initialize and script ActiveX controls not marked as safe

Enable: Run ActiveX controls and plug-ins

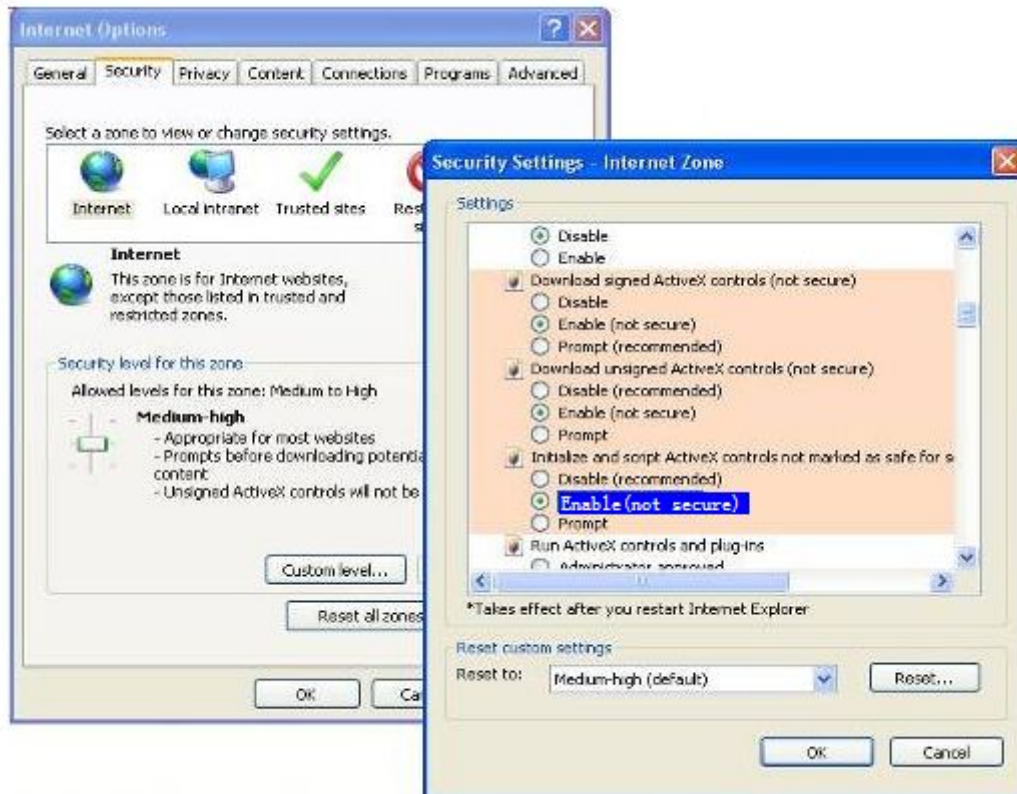

Figure 6.10

If you allow the ActiveX running, but still could not see living video. Please change another port number to try. Don't use port 8000.

		Save	Refresh
HTTP Port	88		
Media Port	88		
HTTPS Port	443		

Figure 6.11

NOTE: Make sure that your firewall or anti-virus software does not block the camera or ActiveX. If you could not see video, please shut down firewall or anti-virus software to try again.

6.1.7 Can't access IP camera in internet

There are some reasons:

- 1 ActiveX controller is not installed correctly
- 2 The port which camera used is blocked by Firewall or Anti-virus software. Please change another port number and try again.

3 Port forwarding is not successful.

Check these settings and make sure they are correct.

6.1.8 UPnP always failed

UPnP only contains port forwarding in our recent software. Sometimes, it may be failed to do port forwarding automatically because of firewall or anti-virus software. It also has much relation with router's security settings. So we recommend you do port forwarding manually. You can view your camera in internet successfully after you do port forwarding manually in your router.

6.1.9 Camera can not connect wireless

If your camera could not connect wireless after you set wireless settings and plug out the cable. Please check whether your settings are correct or not.

Normally, camera can't connect wireless mainly because of wrong settings.

Make sure broadcast your SSID; use the same encryption for router and camera.

6.2 Default Parameters

Default network Parameters

IP address: obtain dynamically

Subnet mask: obtain dynamically

Gateway: obtain dynamically

DDNS: Embedded FOSCAM DDNS Service

Username and password

Default admin username: admin with a blank password

6.3 Specification

ITEMS		FI9803P
Image Sensor	Sensor	High Definition Color CMOS Sensor
	Display Resolution	1.0 Megapixels
	Min. Illumination	0 Lux (With IR Illuminator)
Lens	Lens Type	Glass Lens
	focal length	f:2.8mm
	Aperture	F1.2
	Angle of View	Horizontal:70° Diagonal :75°
Video	Image Compression	H.264
	Image Frame Rate	23fps(1280 x 720), 25fps(VGA),25fps(QVGA)
	Stream	dual stream
	Image adjustment	The hue, brightness, contrast, saturation, sharpness are adjustable

	Flip image	flip and mirror
	Infrared mode	Automatic or manual
	Night visibility	With 1 Infrared Lamp Array, Night Vision Range up to 20m
Network	Ethernet	One 10/100Mbps RJ45 port
	Wireless Standard	IEEE 802.11b/g/n
	Data Rate	IEEE802.11b: 11Mbps(Max.); IEEE802.11g: 54Mbps(Max.); IEEE802.11n: 150Mbps(Max.).
	Wireless Security	WEP, WPA, WPA2
	Remote Access	P2P DDNS
	Network Protocol	IP, TCP, UDP, HTTP, HTTPS, SMTP, FTP, DHCP, DDNS, UPnP, RTSP, ONVIF
System Requirements	Operating System	Microsoft Windows 2000/XP, Vista, 7,8; Mac OS
	Browser	Microsoft IE8 and above version or compatible browser; Mozilla Firefox; Google Chrome; Apple Safari.
Other Features	Motion Detection	Alarm via E-Mail, upload alarm snapshot to FTP
	User Accounts	Three levels user role
	Firewall	Supports IP Filtering
	Reset	Reset button is available
Power	Power Supply	DC 12V/1.0A
	Power Consumption	4.2 Watts (Max.)
Physical	Dimension(mm)	153(L)x 92(W)x 86(H)
	Net Weight	380g
Environment	Operating Temperature	-20°C ~ 60°C (-4°F ~ 140°F)
	Operating Humidity	10% ~ 80% non-condensing
	Storage Temperature	-20°C ~ 60°C (-4°F ~ 140°F)
	Storage Humidity	0% ~ 90% non-condensing
Certification	IC、CSA、CE、FCC、RoHS	
Warranty	Limited 2-year warranty	

ITEMS	FI9803EP	
Image Sensor	Sensor	High Definition Color CMOS Sensor
	Display Resolution	1.0 Megapixels
	Min. Illumination	0 Lux (With IR Illuminator)
Lens	Lens Type	Glass Lens
	focal length	f: 4mm(option 2.8mm,6mm,8mm)
	Aperture	F1.2
	Angle of View	Horizontal:70°

		Diagonal :75°
Video	Image Compression	H.264
	Image Frame Rate	30fps(60Hz), 25fps(50Hz), downward adjustable
	Resolution	720P(1280 x 720), VGA(640 x 480), QVGA(320 x 240)
	Stream	dual stream
	Image adjustment	The hue, brightness, contrast, saturation, sharpness are adjustable
	Flip image	flip and mirror
	Infrared mode	Automatic or manual
	Night visibility	Infrared lamp array, night vision range up to 20 meters
Network	Ethernet	One 10/100Mbps RJ45 port
	Remote Access	P2P DDNS
	PoE	IEEE. 802.3af
	Network Protocol	IP, TCP, UDP, HTTP, HTTPS, SMTP, FTP, DHCP, DDNS, UPnP, RTSP, ONVIF
System Requirements	Operating System	Microsoft Windows 2000/XP, Vista, 7; Mac OS
	Browser	Microsoft IE8 and above version or compatible browser; Mozilla Firefox; Google Chrome; Apple Safari.
Other Features	Motion Detection	Alarm via E-Mail, upload alarm snapshot to FTP
	Privacy Block	Set privacy area manually
	User Accounts	Three levels user role
	Firewall	Supports IP Filtering
	Storage	SD card and local storage
	Reset	Reset button is available
Power	Power Supply	DC 12V/1.0A
	Power Consumption	4.2 Watts (Max.)
Physical	Dimension(mm)	153(L)x 92(W)x 86(H)
	Net Weight	380g
Environment	Operating Temperature	-20°C ~60°C (-4°F ~ 140°F)
	Operating Humidity	10% ~ 80% non-condensing
	Storage Temperature	-20°C ~ 60°C (-4°F ~ 140°F)
	Storage Humidity	0% ~ 90% non-condensing
Certification	CE, FCC, RoHS	
Warranty	Limited 2-year warranty	

ITEMS	FI9903P	
Image Sensor	Sensor	High Definition Color CMOS Sensor
	Display Resolution	1920 x 1080 (2.0M Pixels)
	Min. Illumination	0 Lux (With IR Illuminator)

Lens	Lens Type	Glass Lens
	focal length	f:4mm, 6mm/8mm/12mm Option
	Aperture	F1.2
	Angle of View	Horizontal:70° Diagonal :75°
Video	Image Compression	H.264
	Image Frame Rate	30fps(60Hz), 25fps(50Hz), downward adjustable
	Resolution	1080P(1920x1080),720P(1280 x 720), VGA(640 x 480), QVGA(320 x 240)
	Stream	dual stream
	Image adjustment	The hue, brightness, contrast, saturation, sharpness are adjustable
	Flip image	flip and mirror
	Infrared mode	Automatic or manual
Night visibility	With 2 Infrared Lamp Array, Night Vision Range up to 30m	
Network	Ethernet	One 10/100Mbps RJ45 port
	Remote Access	P2P DDNS
	Network Protocol	IP, TCP, UDP, HTTP, HTTPS, SMTP, FTP, DHCP, DDNS, UPnP, RTSP, ONVIF
System Requirements	Operating System	Microsoft Windows 2000/XP, Vista, 7,8; Mac OS
	Browser	Microsoft IE8 and above version or compatible browser; Mozilla Firefox; Google Chrome; Apple Safari.
Other Features	Motion Detection	Alarm via E-Mail, upload alarm snapshot to FTP
	Privacy Block	Set privacy area manually
	User Accounts	Three levels user role
	Firewall	Supports IP Filtering
	Reset	Reset button is available
Physical	Dimension(mm)	153(L)x 92(W)x 86(H)
	Net Weight	380g
	Power Consumption	<14 Watts
Environment	Operating Temperature	-20°C ~ 60°C (-4°F ~ 140°F)
	Operating Humidity	10% ~ 80% non-condensing
	Storage Temperature	-20°C ~ 60°C (-4°F ~ 140°F)
	Storage Humidity	0% ~ 90% non-condensing
Certification	CE, FCC, RoHS	
Warranty	Limited 2-year warranty	

ITEMS		FI9804W
Image Sensor	Sensor	High Definition Color CMOS Sensor
	Display Resolution	1.0 Megapixels
	Min. Illumination	0 Lux (With IR Illuminator)
Lens	Lens Type	Glass Lens
	focal length	f:2.8mm
	Aperture	F1.2
	Angle of View	Horizontal:70° Diagonal :75°
Video	Image Compression	H.264
	Image Frame Rate	30fps(60Hz), 25fps(50Hz), downward adjustable
	Resolution	720P(1280 x 720), VGA(640 x 480), QVGA(320 x 240)
	Stream	dual stream
	Image adjustment	The hue, brightness, contrast, saturation, sharpness are adjustable
	Flip image	flip and mirror
	Infrared mode	Automatic or manual
	Night visibility	12pcs IR-LEDs, night vision range up to 20 metres
Audio	Input/Output	External standard 3.5mm interface for two-way audio
	Audio Compression	PCM/G.726
Network	Ethernet	One 10/100Mbps RJ45 port
	Wireless Standard	IEEE802.11b/g/n
	Data Rate	IEEE802.11b: 11Mbps(Max.); IEEE802.11g: 54Mbps(Max.); IEEE802.11n: 150Mbps(Max.).
	Wireless Security	WEP, WPA, WPA2
	Network Protocol	IP, TCP, UDP, HTTP, HTTPS, SMTP, FTP, DHCP, DDNS, UPnP, RTSP, ONVIF
System Requirements	Operating System	Microsoft Windows 2000/XP, Vista, 7; Mac OS iOS, Android
	Browser	Microsoft IE8 and above version or compatible browser; Mozilla Firefox; Google Chrome; Apple Safari.
Other Features	Motion Detection	Alarm via E-Mail, upload alarm snapshot to FTP
	Privacy Block	Set privacy area manually
	User Accounts	Three levels user role
	Firewall	Supports IP Filtering
	Reset	Reset button is available
Power	Power Supply	DC 12V/1.0A
	Power Consumption	5.5 Watts (Max.)
	Dimension(mm)	132(L)x 72(W)x 80(H)

Physical	Gross Weight	1186.8g
	Net Weight	870g
Environment	Operating Temperature	-20°C~ 60°C (-4°F ~ 140°F)
	Operating Humidity	10% ~ 80% non-condensing
	Storage Temperature	-20°C ~ 60°C (-4°F ~ 140°F)
	Storage Humidity	0% ~ 90% non-condensing
Certification	CE, FCC, RoHS	
Warranty	Limited 2-year warranty	

Specification		FI9805W
Image Sensor	Image Sensor	High Definition Color CMOS Sensor
	Display Resolution	1.3 Megapixels
	Mini. Illumination	0 Lux (With IR Illuminator)
Lens	focal length	f 4mm
	Aperture	F1.2
	Angle of View	Horizontal:70° Diagonal :75°
Video	Resolution	960p(1280 x 960), 720p(1280 x 720), VGA(640 x 480)
	View	H.264 dual streaming
	Image adjust	The brightness, contrast, saturation, chromaticity, is adjustable
	Infrared mode	Off & Manually
	Night visibility	Φ8mm 36 IR LEDs, Night visibility up to 30 meters
Network	Ethernet	One 10/100Mbps RJ-45
	Supported Protocol	TCP/IP, UDP/IP, HTTP, SMTP, FTP, DHCP, RTSP,HTTPS, DDNS, UPNP, ONVIF
	Wireless Standard	WIFI(IEEE802.11b/g/n)
	Support IP address	static IP address, dynamic IP address
Alarm	Alarm detection	The motion detecting
	Alarm inform	Support Email、FTP etc alarm inform way
Hardware Interface	POWER Interface	DC 12V/2.0A (EU,US,AU adapter or other types option), Power Consumption < 8 Watts
	Audio Input/Output Interface	One audio input jack, One audio output jack.
	Reset Buttons	One Reset
Environment	Operate Temper	-20°C ~ 60°C (-4°F ~ 140°F)
	Operate Humidity	10% ~ 80% non-condensing
	Storage Temper	-20°C ~ 60°C(-4°F ~ 140°F)
	Storage Humidity	0% ~ 90% non-condensing
	Dimension(mm)	180(L)x 98(W)x 103(H)
	Net Weight	1300g

PC	CPU	2.0GHZ or above (suggested 3.0GHz)
	Memory Size	256MB or above (suggested 1.0GHz)
Requirements	Display Card	64M or above
	Supported OS	Microsoft Windows 2000/XP, Vista, 7; Mac OS iOS, Android
	Browser	IE8 and above version or compatible browser, Firefox, Chrome, Safari or other standard browsers
Software	Upgrade	Upgrade from network
Certification	IC、CE, FCC, RoHS	
Warranty	Limited 2-year warranty	

Specification		F19805E
Image Sensor	Image Sensor	High Definition Color CMOS Sensor
	Lens	f : 4mm
	Mini. Illumination	0 Lux (With IR Illuminator)
Lens	Lens Type	Glass Lens
	IR_CUT	Filter can switch automatically
	Angle of View	Horizontal:70° Diagonal :75°
Audio	Input/Output	Linear Input/Output, which can realize two-way voice the intercom
Video	Image Compression	H.264
	Image Frame Rate	25fps(50Hz), 30fps(60Hz),Down adjustable
	Resolution	960p(1280 x 960),720p(1280 x 720),VGA(640 x 480),
	View	H.264 dual streaming
	Image adjust	The brightness, contrast, saturation, chromaticity, is adjustable
	Infrared mode	Auto & Manually
	Night visibility	Φ8mm 36 IR LEDs, Night visibility up to 30 meters
Network	Ethernet	One 10/100Mbps RJ-45
	Supported Protocol	TCP/IP, UDP/IP, HTTP, SMTP, FTP, DHCP, DDNS,UPNP, ONVIF
	Support IP address	static IP address, dynamic IP address
Alarm	Alarm detection	The motion detecting 、 I/O alarm
	Alarm inform	Support Email、FTP、I/O output alarm etc alarm inform way
Hardware Interface	POWER Interface	DC 12V/2.0A (EU,US,AU adapter or other types option), Power Consumption < 8 Watts
	Audio Input/Output Interface	One audio input jack, One audio output jack.
	Reset Buttons	One Reset

	I/O alarm interface	External Input / output terminal block
	Control Interface	one RS - 485 port, support of transparent channel transmission
PoE	PoE Standard	IEEE 802.3af
	Input Voltage	DC 36V~DC 57V
	Output Voltage	DC 12V/2.0A
	Output Power	15.4W (Max.)
	Wiring standards	100M BASE-T
Environment	Operate Temper	-20°C ~ 60°C (-4°F ~ 140°F)
	Operate Humidity	20% ~ 85% non-condensing
	Storage Temper	-20°C ~ 60°C (-4°F ~ 140°F)
	Storage Humidity	0% ~ 90% non-condensing
	Dimension	245(L)X196(W)X112(H)mm.
	Net Weight	900g
	Gross Weight	1150g
PC Requirements	CPU	2.0GHZ or above (suggested 3.0GHz)
	Memory Size	256MB or above (suggested 1.0GHz)
	Display Card	64M or above
	Supported OS	Microsoft Windows 2000/XP, Vista, 7; Mac OS iOS, Android
	Browser	IE8 and above version or compatible browser, Firefox, Chrome, Safari or other standard browsers
Software	Upgrade	Upgrade from network
Certification	CE,FCC,RoHS	
Warranty	Limited 2-year warranty	

ITEMS		FI9900P
Image Sensor	Sensor	High Definition Color CMOS Sensor
	Display Resolution	1920 x 1080 (2.0M Pixels)
	Min. Illumination	0 Lux (With IR Illuminator)
Lens	Lens Type	Glass Lens
	focal length	f:2.8mm
	Aperture	F1.2
	Angle of view	Horizontal:96° , Diagonal :102°
Video	Image Compression	H.264
	Image Frame Rate	30fps(60Hz), 25fps(50Hz), downward adjustable
	Resolution	1080P(1920x1080),720P(1280 x 720), VGA(640 x 480), QVGA(320 x 240)
	Stream	dual stream

	Image adjustment	The hue, brightness, contrast, saturation, sharpness are adjustable
	Flip image	flip and mirror
	Infrared mode	Automatic or manual
	Night visibility	With 30pcs IR-LED, Night Vision Range up to 20m
Audio	Input/Output	External RCA interface for two-way audio
	Audio Compression	PCM/G.726
Network	Ethernet	One 10/100Mbps RJ45 port
	Wireless Standard	IEEE802.11b/g/n
	Data Rate	IEEE802.11b: 11Mbps(Max.); IEEE802.11g: 54Mbps(Max.); IEEE802.11n: 150Mbps(Max.).
	Wireless Security	WEP, WPA, WPA2
	Remote Access	P2P DDNS
	Network Protocol	IP、TCP、UDP、HTTP、HTTPS、SMTP、FTP、DHCP、DDNS、UPnP、RTSP、ONVIF
System Requirements	Operating System	Microsoft Windows 2000/XP, Vista, 7,8; Mac OS
	Browser	Microsoft IE8 and above version or compatible browser; Mozilla Firefox; Google Chrome; Apple Safari.
Other Features	Motion Detection	Alarm via E-Mail, upload alarm snapshot to FTP
	Privacy Block	Set privacy area manually
	User Accounts	Three levels user role
	Firewall	Supports IP Filtering
	Reset	Reset button is available
Power	Power Supply	DC 12V/1.0A
	Power Consumption	5 Watts (Max.)
Physical	Dimension(LxWxH)	98(L)x65 (W)x62 (H)
	Net Weight	255g
Environment	Waterproof	IP66
	Operating Temperature	-10°C~ 60°C (14°F ~ 140°F)
	Operating Humidity	10% ~ 80% non-condensing
	Storage Temperature	-20°C ~ 60°C (-4°F ~ 140°F)
	Storage Humidity	0% ~ 90% non-condensing
Certification	FCC、IC、CE、WEEE、IP66	
Warranty	Limited 2-year warranty	

ITEMS		FI9900EP
Image Sensor	Sensor	High Definition Color CMOS Sensor
	Display Resolution	1920 x 1080 (2.0M Pixels)
	Min. Illumination	0 Lux (With IR Illuminator)
Lens	Lens Type	Glass Lens
	focal length	f:2.8mm
	Aperture	F1.2
	Angle of view	Horizontal:96° , Diagonal :102°
Video	Image Compression	H.264
	Image Frame Rate	30fps(60Hz), 25fps(50Hz), downward adjustable
	Resolution	1080P(1920x1080),720P(1280 x 720), VGA(640 x 480), QVGA(320 x 240)
	Stream	dual stream
	Image adjustment	The hue, brightness, contrast, saturation, sharpness are adjustable
	Flip image	flip and mirror
	Infrared mode	Automatic or manual
	Night visibility	With 30pcs IR-LED, Night Vision Range up to 20m
Audio	Input/Output	External RCA interface for two-way audio
	Audio Compression	PCM/G.726
Network	Ethernet	One 10/100Mbps RJ45 port
	Remote Access	P2P DDNS
	Network Protocol	IP、TCP、UDP、HTTP、HTTPS、SMTP、FTP、DHCP、DDNS、UPnP、RTSP、ONVIF
System Requirements	Operating System	Microsoft Windows 2000/XP, Vista, 7,8; Mac OS
	Browser	Microsoft IE8 and above version or compatible browser; Mozilla Firefox; Google Chrome; Apple Safari.
Other Features	Motion Detection	Alarm via E-Mail, upload alarm snapshot to FTP
	Privacy Block	Set privacy area manually
	User Accounts	Three levels user role
	Firewall	Supports IP Filtering
	Reset	Reset button is available
Power	Power Supply	DC 12V/1.0A
	POE Standard	802.3af
	Power Consumption	5 Watts (Max.)
Physical	Dimension(LxWxH)	98(L)x65 (W)x62 (H)
	Net Weight	255g
Environment	Waterproof	IP66

	Operating Temperature	-10°C~ 60°C (14°F ~ 140°F)
	Operating Humidity	10% ~ 80% non-condensing
	Storage Temperature	-20°C ~ 60°C (-4°F ~ 140°F)
	Storage Humidity	0% ~ 90% non-condensing
Certification	FCC、IC、CE、WEEE、IP66	
Warranty	Limited 2-year warranty	

ITEMS		FI9800P
Image Sensor	Sensor	High Definition Color CMOS Sensor
	Display Resolution	1080 x 720 (1.0M Pixels)
	Min. Illumination	0 Lux (With IR Illuminator)
Lens	Lens Type	Glass Lens
	focal length	f:2.8mm
	Aperture	F1.2
	Angle of View	Horizontal:70° Diagonal :75°
Video	Image Compression	H.264
	Image Frame Rate	30fps(60Hz), 25fps(50Hz), downward adjustable
	Resolution	720P(1280 x 720), VGA(640 x 480), QVGA(320 x 240)
	Stream	dual stream
	Image adjustment	The hue, brightness, contrast, saturation, sharpness are adjustable
	Flip image	flip and mirror
	Infrared mode	Automatic or manual
Audio	Night visibility	With 30pcs IR-LED, Night Vision Range up to 20m
	Input/Output	External RCA interface for two-way audio
Audio	Audio Compression	PCM/G.726
Network	Ethernet	One 10/100Mbps RJ45 port
	Wireless Standard	IEEE 802.11b/g/n
	Data Rate	IEEE802.11b: 11Mbps(Max.); IEEE802.11g: 54Mbps(Max.); IEEE802.11n: 150Mbps(Max.).
	Wireless Security	WEP, WPA, WPA2
	Remote Access	P2P DDNS
	Network Protocol	IP, TCP, UDP, HTTP, HTTPS, SMTP, FTP, DHCP, DDNS, UPnP, RTSP, ONVIF
System Requirements	Operating System	Microsoft Windows 2000/XP, Vista, 7,8; Mac OS
	Browser	Microsoft IE8 and above version or compatible browser; Mozilla Firefox; Google Chrome;

		Apple Safari.
Other Features	Motion Detection	Alarm via E-Mail, upload alarm snapshot to FTP
	Privacy Block	Set privacy area manually
	User Accounts	Three levels user role
	Firewall	Supports IP Filtering
	Reset	Reset button is available
Power	Power Supply	DC 12V/1.0A
	Power Consumption	4.2 Watts (Max.)
Physical	Dimension(mm)	97(L)x67 (W)x64 (H)
	Net Weight	350g
Environment	Waterproof	IP66
	Operating Temperature	-10°C ~ 55°C (14°F ~ 140°F)
	Operating Humidity	10% ~ 80% non-condensing
	Storage Temperature	-20°C ~ 60°C (-4°F ~ 140°F)
	Storage Humidity	0% ~ 90% non-condensing
Certification	FCC、IC、CE、WEEE、IP66	
Warranty	Limited 2-year warranty	

ITEMS		FI9901EP
Image Sensor	Sensor	High Definition Color CMOS Sensor
	Display Resolution	2560*1440 (4.0M Pixels)
	Min. Illumination	0 Lux (With IR Illuminator)
Lens	Lens Type	Glass Lens
	focal length	f:2.8mm
	Aperture	F1.2
Video	Image Compression	H.264
	Image Frame Rate	30fps(60Hz), 25fps(50Hz), downward adjustable
	Resolution	4.0M (2560*1440),3.0M(2304*1296), 1080P(1920x1080),720P(1280 x 720), VGA(640 x 480), QVGA(320 x 240)
	Stream	dual stream
	Image adjustment	The hue, brightness, contrast, saturation, sharpness are adjustable
	Flip image	flip and mirror
	Infrared mode	Automatic or manual
	Night visibility	With 30pcs IR-LED, Night Vision Range up to 20m
Audio	Input/Output	External RCA interface for two-way audio
	Audio Compression	PCM/G.726

Network	Ethernet	One 10/100Mbps RJ45 port
	Remote Access	P2P DDNS
	Network Protocol	IP、TCP、UDP、HTTP、HTTPS、SMTP、FTP、DHCP、DDNS、UPnP、RTSP、ONVIF
System Requirements	Operating System	Microsoft Windows 2000/XP, Vista, 7,8; Mac OS
	Browser	Microsoft IE8 and above version or compatible browser; Mozilla Firefox; Google Chrome; Apple Safari.
Other Features	Motion Detection	Alarm via E-Mail, upload alarm snapshot to FTP
	Privacy Block	Set privacy area manually
	User Accounts	Three levels user role
	Firewall	Supports IP Filtering
	Reset	Reset button is available
Power	Power Supply	DC 12V/1.0A
	POE Standard	802.3af
	Power Consumption	5 Watts (Max.)
Physical	Dimension(LxWxH)	98(L)x65 (W)x62 (H)
	Net Weight	255g
Environment	Waterproof	IP66
	Operating Temperature	-10°C~ 60°C (14°F ~ 140°F)
	Operating Humidity	10% ~ 80% non-condensing
	Storage Temperature	-20°C ~ 60°C (-4°F ~ 140°F)
	Storage Humidity	0% ~ 90% non-condensing
Certification	FCC、IC、CE、WEEE、IP66	
Warranty	Limited 2-year warranty	

Attention: Power adapter should be used between -20°C-40°C, and 20%-90% relative humidity.

6.4 CE & FCC

Electromagnetic Compatibility (EMC)

FCC Statement



This device complies with FCC Rules Part 15 of the FCC Rules. Operation is subject to the following two conditions.

- This device may not cause harmful interference, and
- This device must accept any interference received, including interference that may cause undesired operation.

This equipment has been tested and found to comply with the limits for a Class A digital device, pursuant to Part 15 of the FCC Rules. These limits are designed to provide reasonable protection against harmful interference when the equipment is operated in a commercial environment. This equipment generates, uses, and can radiate radio frequency energy and, if not installed and used in accordance with the installation manual, may cause harmful interference to radio communications. Operation of this equipment in a residential area is like to cause harmful interference, in which case the user will be required to correct the interference at his own expense.

FCC Caution

Any changes or modification not expressly approved by the party responsible for compliance could void the user's authority to operate this equipment.

This equipment complies with FCC radiation exposure limits set forth for an uncontrolled environment. This equipment should be installed and operated with minimum distance 20cm between the radiator& your body.

This transmitter must not be co-located or operating in conjunction with any other antenna or transmitter.

CE Mark Warning



This is a Class A product. In a domestic environment, this product may cause radio interference, in which case the user may be required to take adequate measures.

6.5 WARRANTY

ShenZhen FOSCAM Intelligent Technology Limited.("FOSCAM") values your business and always attempts to provide you the very best of service.

No limited hardware warranty is provided by FOSCAM unless your FOSCAM product ("product") was purchased from an authorized distributor or authorized reseller. Distributors may sell products to resellers who then sell products to end users. No warranty service is provided unless the product is returned to an authorized return center in the region where the product was first shipped by FOSCAM or to the point-of-purchase, which may have regional specific warranty implications.

If you purchase your FOSCAM product from online store, please contact the point-of-purchase and ask for return/replacement/repair service.

Hardware Warranty Information

FOSCAM provide 2-year limited warranty for naked product and 6-month limited warranty for accessories.

Limited Hardware Warranty

FOSCAM products are warranted to be free from manufacturing defects in materials and workmanship starting

from the shipping date of FOSCAM.

This limited hardware warranty does not cover:

- Software, including the software added to the products through our factory-integration system, software that included in the CD, etc.
- Usage that is not in accordance with product instructions.
- Failure to follow the product instructions.
- Abuse firmware upgrade without the authorized technician's guidance.
- Normal wear and tear.

Return Procedures

- Please read FOSCAM warranty policy & policy of your reseller first before sending items back to point-of-purchase.
- Customer must first contact point-of-purchase to obtain a Return Merchandise Authorization (RMA) number before returning the product. If the product you received is suspected to be defective and the product warranty has not expired, The RMA number will allow your reseller to track your return much easier and help them expedite processing your request.
- After receiving your RMA case number, pack the item(s) very well with the original box and all the original accessories included such as power adapters, brackets, cables, manuals, and driver CD disks.
- Write your RMA number and the return reason (the problem of the product) on the warranty card along with the complete package to send them back.

Replacement Services

- **If customers ask for replacement service, please contact point-of-purchase and follow their policy.**
- Our technicians will inspect all items returned for replacement requests. If the returned product is found in working order, we will return the same item received. However customers shall be responsible for all shipping & handling charges incurred for getting the units back to customers.
- If returned products are found defective, we will replace the product and assume the shipping cost for sending back the replacement unit to customers.
- If for any reason, we are unable to provide a replacement of the original returned item(s). You will have a choice for a "Substitute" item at the same equal value.
- We do not provide exchange and replacement due to normal hardware upgrade according the market after 14 days after the product is delivered.
- Our technicians will test the product before send out the replacement, any other demand for more than two times replacement for the same product during replacement limit will be rejected.
- **Replaced products are warranted from the balance of the former warranty period.**

Warranty Forfeiture

- Warranty is void if purchase from unauthorized distributor or reseller.
- **Warranty is void if trade-mark, serial tags, product stickers have been removed, altered or tampered with.**
- Warranty is void for mishandling, improper use, or defacing the product.
- **Abuse firmware upgrade without the authorized technician's guidance.**
- Warranty is void for physical damage, altered, either internally or externally, improper or inadequate packaging when returned for RMA purposes.
- Warranty is void if damage has resulted from accident, dismantle, abuse, or service or modification by someone other than the appointed vendor, source, fission or the spare part has been over the period of

warranty.

- Warranty is void if product is damaged due to improper working environment or operation. (For example, improper temperature, humidity, unusual physical or electrical stress or interference, failure or fluctuation of electrical power, static electricity, using wrong power adapter, etc.)
- Warranty is void if damaged by the use of parts not manufactured or sold by FOSCAM.
- Damage caused by improper installation of third-party products.
- Warranty is void if damaged for irresistible cause, such as earthquake, fire, lightning, flood, etc.
- Product beyond limited warranty.

Shipping Fee

- If products are defective or damaged under normal use or operation in the replacement limit, distributors or resellers are responsible for the shipping cost the product back to customers, customers should assume the shipping cost send the product to the point-of-purchase.
- During replacement limit, if customers ask for replacement due to the product does not fit for customer's personal expectation, customers should responsible for both shipping fee.
- Customers shall be responsible for both shipping fee if their product beyond the replacement limit but still in warranty limit.

Repair Service Out Of Warranty

- FOSCAM provide extra repair service for product that out of warranty, it is chargeable. The total fee contains device cost and service fee. Device cost (including accessories) is the standard uniform price provide by FOSCAM.
- Different region may have different service fee, please contact the point-of-purchase to confirm that before you ask for this service.
- Our technicians will quote the total price after detect the product, If customers refused to repair after the quotation, customers need pay for the test fee, \$3.5/hour. If agree with the quotation, test will be free.
- Repaired product out of warranty will obtains 3-month warranty from the date of the product back to customers.

Limitation of Liability

- FOSCAM is not responsible for other extra warranty or commitment promised by resellers, if your reseller promised some extra commitment or warranty; please ask for written documents to protect your rights and interests.
- FOSCAM does not offer refunds under any circumstances. Please contact the point-of-purchase and follow their refund/return policy.
- FOSCAM shall not be liable under any circumstances for any consequential, incidental, special or exemplary damages arising out of or in any connection with this agreement or the products, including but not limited to lost profits, or any claim based on indemnity or contribution, or the failure of any limited or exclusive remedy to achieve its essential purpose or otherwise. Purchaser's exclusive remedy, as against FOSCAM, shall be the repair or replacement of defective parts. If FOSCAM lists a product on its website specification in error or that is no longer available for any reason, FOSCAM reserves the right to explain it without incurring any liability.

All rights reserved. FOSCAM and the FOSCAM logo are trademarks of ShenZhen FOSCAM Intelligent Technology Limited., registered in the U.S. and other countries.

6.6 Statement

You are advised to be cautious in daily life, keep personal account information carefully, do not share personal account easily. Change passwords of your account and equipment periodically, and upgrade equipment firmware to strengthen security consciousness.

Our company makes no warranty, implied or otherwise, that this product is suitable for any particular purpose or use. You need to abide by the relevant laws and regulations of the use restrictions when using Foscam cameras. Our company takes no responsibility of illegal activities by using our products.

Our company takes no responsibility of the loss by force majeure, such as failure or faults of telecom system or the Internet network, computer viruses, malicious attacks of hackers, information damage or loss, and faults of computer system.

Foscam company does not need to take any responsibility of the special, incidental or corresponding loss by the products of our company or any software provide by our company, including but not limited to operating loss, profit or purpose. The company only takes the responsibility applicable to national and local legal requirements.

Our company takes no responsibility of the loss caused by the following at any time:

- 1) loss of purchases;
- 2) loss of intangible property damage, such as data, programs;
- 3) loss of compensation claimed by third-party customers.

Delete images, format the memory card or other data storage devices does not completely remove the original image data. You can restore deleted files from discarded the storage device by commercial software, but which will potentially lead to personal image data used maliciously by others. The privacy of the data security belongs to user responsibility, the company takes no responsibility.

Parts mentioned in this statement should not be understood by the configuration description of the product purchased by the customer, the product configuration must accord to the specific models purchased by the customer.

Without the prior written permission of Foscam company, all the contents of relevant operating instructions manual affiliated to the product must not be reproduced, transmitted, transcribed or stored in a retrieval system, or translated into other languages.

Our company will reserve the right to improve and modify the product and corresponding manuals. The company reserves the right of final interpretation on our products.

7 Obtaining Technical Support

While we hope your experience with the IPCAM network camera is enjoyable and easy to use, you may experience some issues or have questions that this User's Guide has not answered.

If you have problem with FOSCAM IP camera, please first contact FOSCAM reseller for solving the problems.

If our reseller cannot provide service, please contact our service department: tech@foscam.com .



CE Certificate Website: <http://www.foscam.com/company/ce-certificate.html>