

PFS 3504 Display Interface Strips, 3D adjustable

The PFS 3504 adjustable display strip is part of a unique and flexible system that is ideal for video wall setups and in-line menu boards. With this modular concept, based on Connect-it, you create a video wall solution for almost every set-up requirement. The video wall solution consists of interface bars (PFB 34xx) and one set of multi directional (3D) adjustable interface display strips (PFS 35xx) per display. Vogel's offers various lengths of interface bars and two different lengths of interface display strips, with fitment 400 mm and 800 mm.

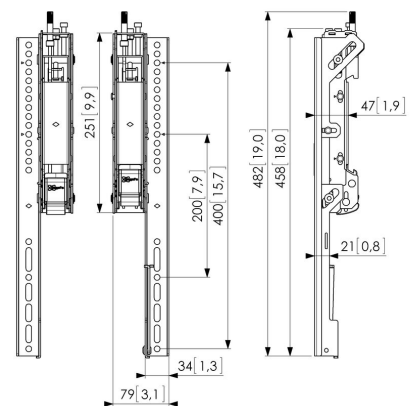



PFS 3504 Display Interface Strips, 3D adjustable

Specifications

Article number (SKU)	7235040
Colour	Black
EAN single box	8712285328800
Height	482
TÜV certified	Yes
Tilt	Tilt -3°/+7°
Guarantee	5 years
Max. weight load (kg)	80
Max. bolt size	M8
Max. height of interface (mm)	482
Max. width of interface (mm)	79
Max. vertical hole pattern (mm)	400
Min. vertical hole pattern (mm)	100
Service position	Yes

VOGEL'S HOLDING BV (©)

All rights reserved.
Subject to printing errors,
technical and price
amendments.

Date: 2022-06-01



Vogel's. For Sure.